

TECHNISCHE DATEN

# ROLF BENZ KUMIO

---



**ROLF  
BENZ**

- Holz-Innengerüst
- Unterfederung: Glasfaserverstärkte Kunststoff-Federleisten
- Sitzkomfort Lounge Deluxe
- Sitz aus hochwertigem Kaltschaum, schichtweise aufgebaut, abgedeckt mit einer Matte bestehend aus 20 % Viscoschaum und 80 % Mikrofasern und einer Hülle aus Polyestervlies.
- Rückenaufgabe aus Polyurethanschaum
- Rückenbezug mit Polyestervlies unterstept
- Polsterabdeckung aufgeklebtes Polyestervlies
- Rückenkissen in Daunencharakter, in Kammern gearbeitet mit einer Füllung aus 20 % Viscoschaum und 80 % Mikrofasern.
- Sitzhöhen wahlweise 43 oder 46 cm
- Gussfuß Metall, wahlweise:
- Aluminium glatt pulverbeschichtet matt:
  - RAL 9017 Verkehrsschwarz
  - RAL 7022 Umbragrau
  - Marrone metallic

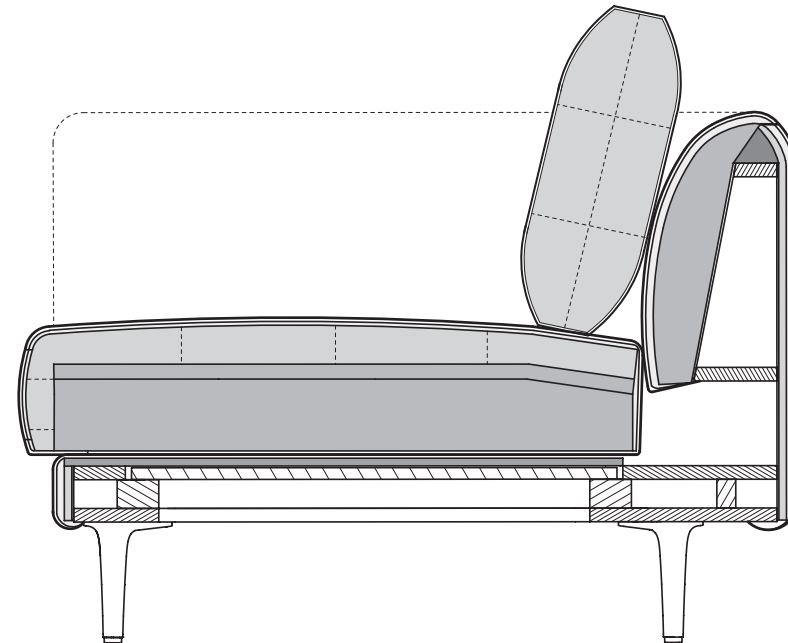

Sitzhöhen lieferbar

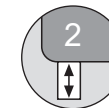

! Hochwertiger, besonders legerer Polsteraufbau mit warentypischer Bildung von Wellen/Sitzabdrücken - stärkeres Wellenbild gegebenenfalls bereits im Neuzustand. Alle Maße sind Zirka-Angaben und können bis zu ca. 4 cm - in Einzelfällen bei angereichten Garnituren auch darüber hinaus – abweichen.

**ROLF  
BENZ**

Anreihsofa rund\*

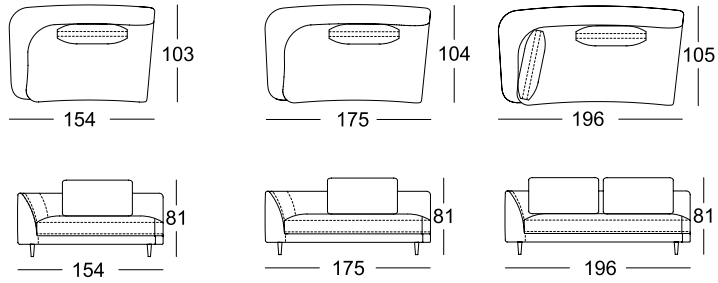

Extra Large  
Anreihsofa rund\*

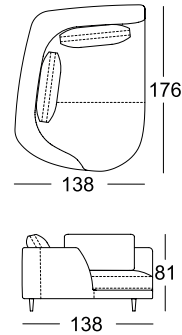

Abschlussessel  
mit Polstersitz rund

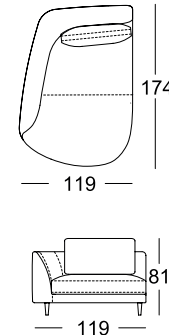

Eck-Anreihsofa rund\*

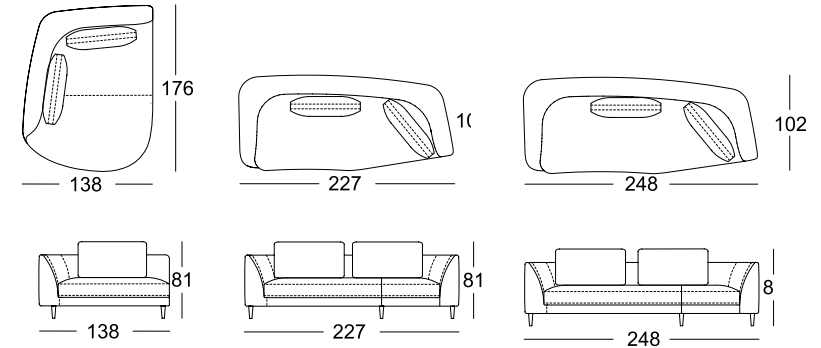

Eck-Anreihbank  
rund\*

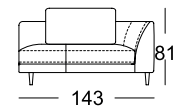
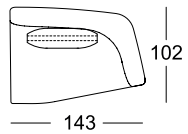

Eck-Anreihbank  
V-förmig\*

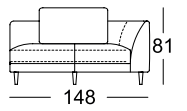
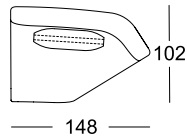

Anreihbank mit  
Polstersitz rund\*

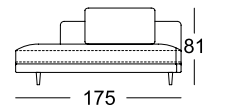
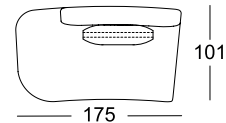

Anreihbank

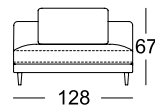
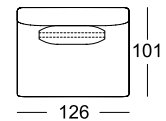

Anreihbank  
rund

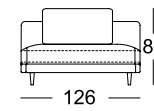
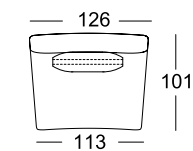
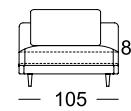
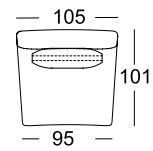

Anreih-  
Polsterbank

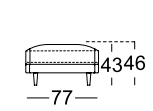
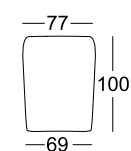

Polsterbank

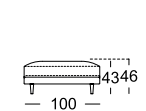
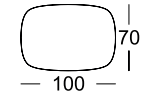

\*Diese Elemente sind in ihrer linken Ausführung abgebildet. Sie sind aber auch gespiegelt in der rechten Ausführung verfügbar.

**ROLF  
BENZ**

Rückenkissenrolle  
hoch

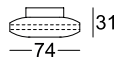

Rückenkissen  
niedrig

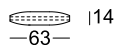

Rückenkissen

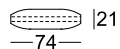

Rückenkissenmatte

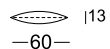

Ablage

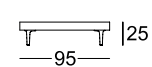
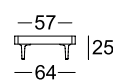
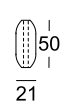
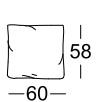
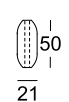
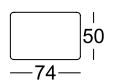
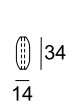
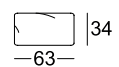
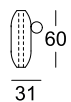
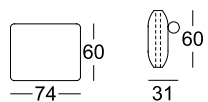
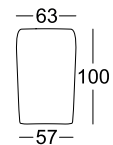

Kombinationsbeispiele

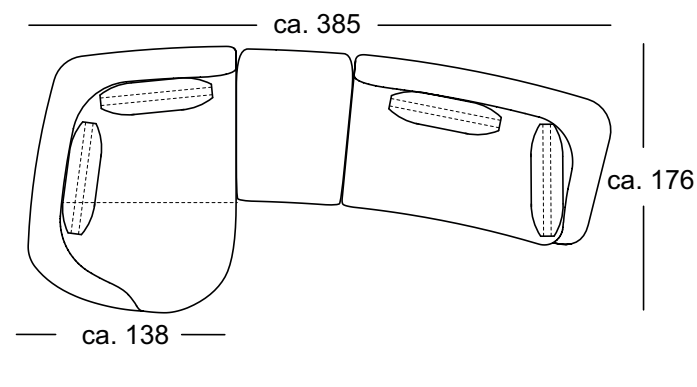
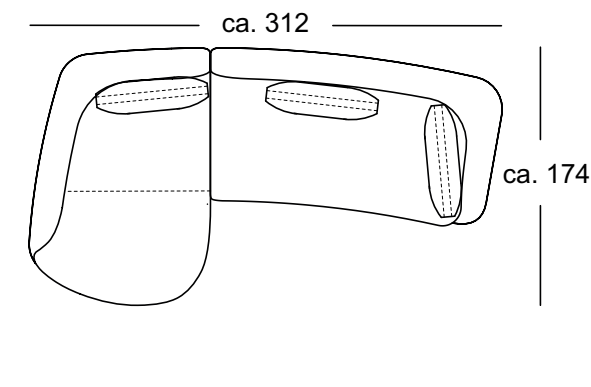
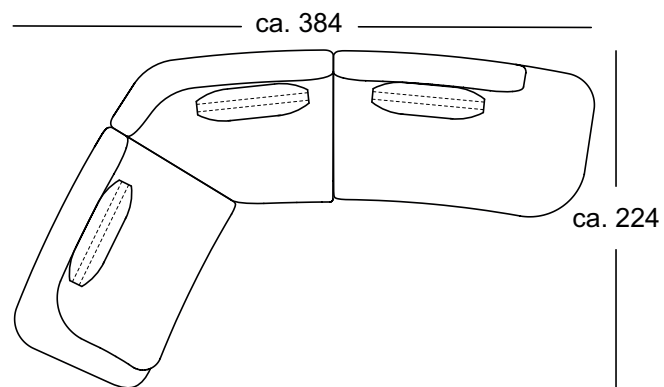

K-ASO-R 555/154 li  
K-E-ARB-V 555/148 re  
K-ARB-PSZ-R 555/175 re  
RUK 555/74 x 50 3x

K-ASS-PSZ-R 555/119 li  
K-ASO-R 555/196 re  
RUK 555/74 x 50 3x

K-XL-ASO-R 555/138 li  
A-PB 555/77  
K-ASO-R 555/175 re  
RUK 555/74 x 50 4x

**ROLF  
BENZ**