



**LIGHTPIECE ANTONIO CITTERIO 2002**

**SOFAS**

---

## LIGHTPIECE | ANTONIO CITTERIO | 2002

**Gestell** Holz und Metall,

Polyurethanpolsterung mit passendem  
Stoffschutzbezug

**Sitzkissen Füllung** aus sterilisierten  
Gänsedaunen (zertifiziert Assopiuma,  
"goldenes Etikett") mit Kern aus  
formbeständigem Material oder aus Pu-  
Schaum und Dacron

**Rückenkissen Füllung** aus sterilisierten  
Gänsedaunen (zertifiziert Assopiuma,  
"goldenes Etikett"), erhältlich in den  
Ausführungen mit und ohne gepolsterter  
Kissenhalterolle aus Pu-Schaum. Die  
Rückenkissen sind auf Anfrage gegen  
Aufpreis erhältlich

**Metallarmlehnregal**

**Aussenseite** in Stahl oder mit Kernleder  
bezogen in den Farben: grau 5003,  
schokoladenbraun 5004,  
schokoladenbraun dunkel 5013, schwarz  
5005, olivgrün 5006, sand 5001, tabak  
5015, leinen 5019, braungrau 5020,  
kastanienbraun 5021, wildleder  
schokoladenbraun 6004, wildleder schwarz  
6005, wildleder olivgrün 6003 und wildleder  
sand 6001.

**Innenseite** Metall lackiert in den Farben:  
weiss (100), beige (130), cremeweiss (150),  
weiss matt (160), creme (205), weinrot  
(405), kakigrün (705), umbragrau (720),  
perlmausgrau (740), braun-grau (805) oder  
schwarz (900)

**Kernlederarmlehnregal**

Metall mit Kernleder bezogen in den  
Farben: grau 5003, schokoladenbraun  
5004, schokoladenbraun dunkel 5013,  
schwarz 5005, olivgrün 5006, sand 5001,  
tabak 5015, leinen 5019, braungrau 5020,  
kastanienbraun 5021, wildleder  
schokoladenbraun 6004, wildleder schwarz  
6005, wildleder olivgrün 6003 und wildleder  
sand 6001.

**Stoffbezogene Armlehne**

**Gestell** aus Holz mit Polyurethanpolsterung  
und passendem Stoffschutzbezug

**Beine:** aus transparentem, glänzendem  
Pmma

**Bezug:** Stoffbezug oder Lederbezug, beide  
Versionen abziehbar

COD. 011P01 ELEMENT

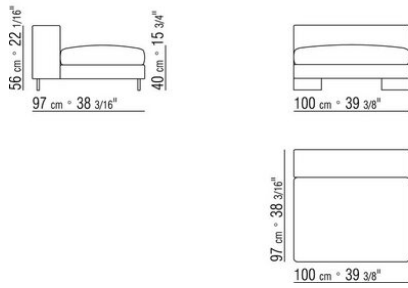

COD. 011P02 ELEMENT

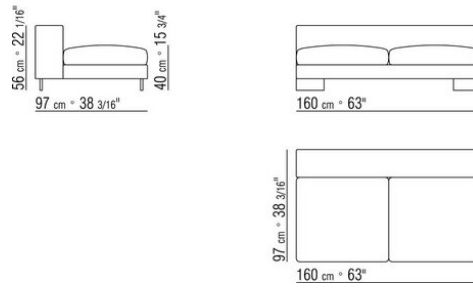

COD. 011P03 ELEMENT

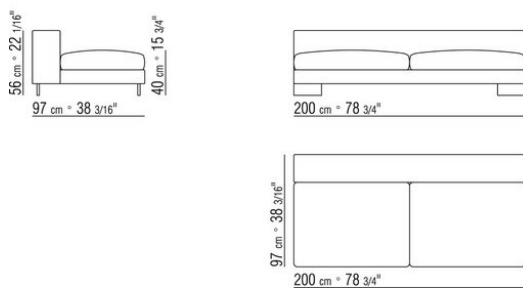

COD. 011P04 ELEMENT

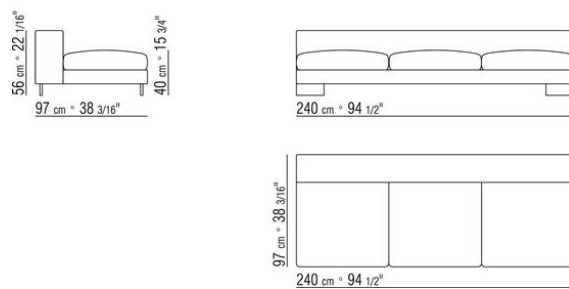

COD. 011P05 ELEMENT

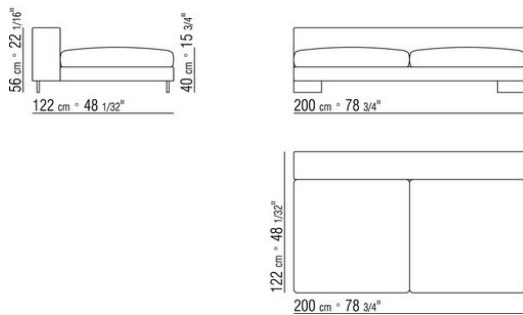

COD. 011P06 ELEMENT

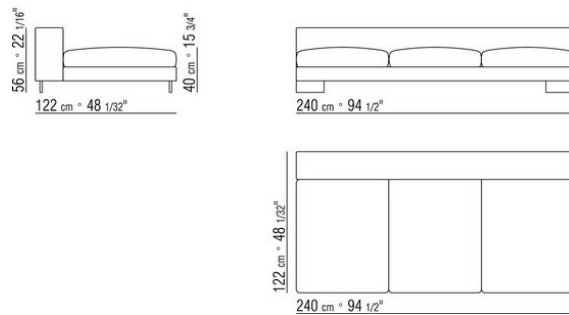

COD. 011P11 ELEMENT / DACRON

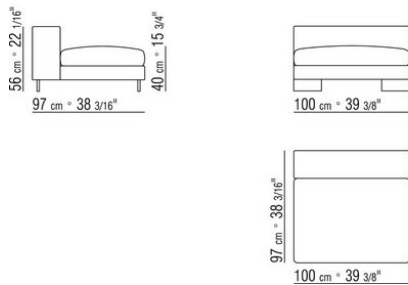

COD. 011P12 ELEMENT / DACRON

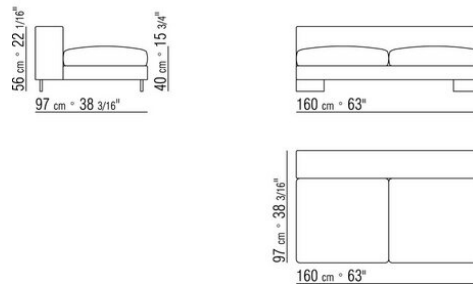

COD. 011P13 ELEMENT / DACRON

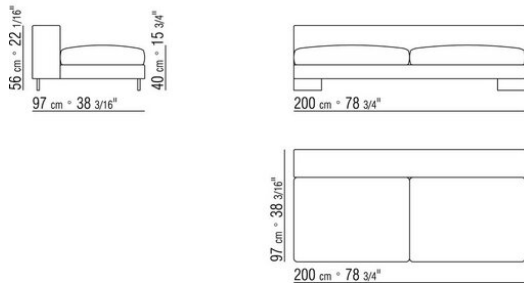

COD. 011P14 ELEMENT / DACRON

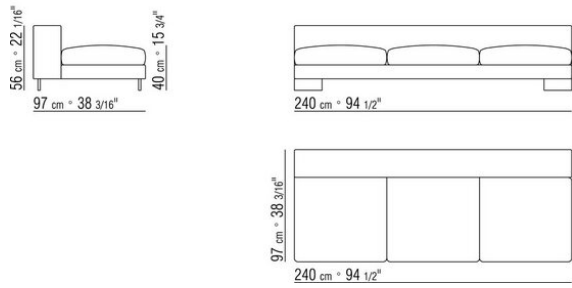

COD. 011P15 ELEMENT / DACRON

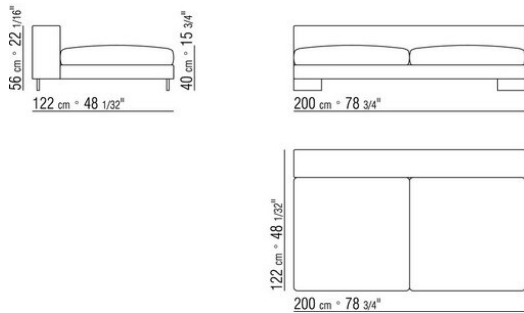

COD. 011P16 ELEMENT / DACRON

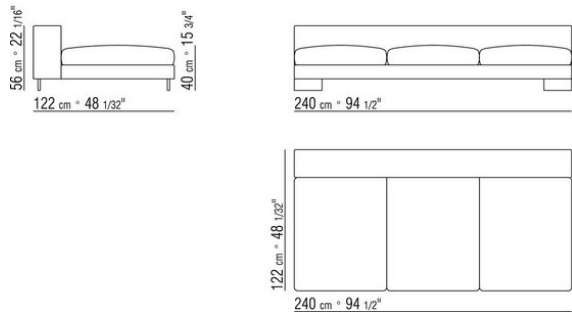

COD. 011P70 ARMLEHNE

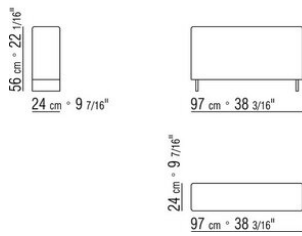

COD. 011P71 ARMLEHNE GEPOLSTERT

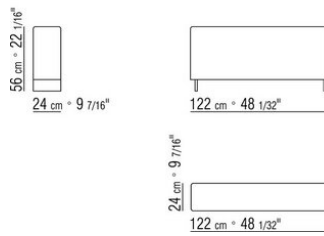

COD. 011P72 ARMLEHNE KERNLEDER

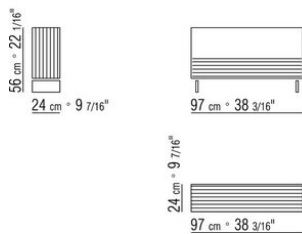

COD. 011P73 ARMLEHNE KERNLEDER

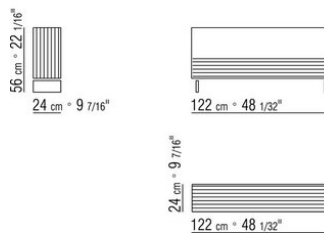

COD. 011P76 ARMLEHNE / METALL

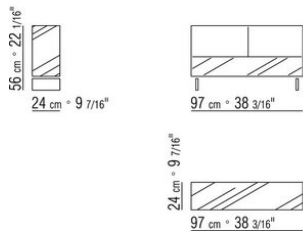

COD. 011P77 ARMLEHNE / METALL

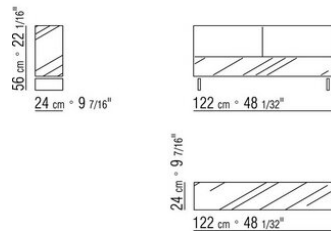

COD. 011P93 KISSEN

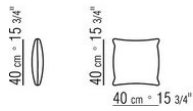

COD. 011P92 KISSEN

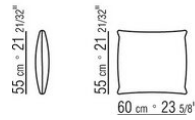

COD. 011P99 KISSEN

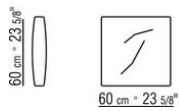

COD. 011P95 KISSEN MIT ROLLE

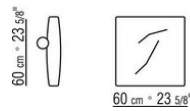

COD. 011P94 KISSEN

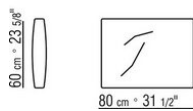

COD. 011P97 KISSEN MIT ROLLE

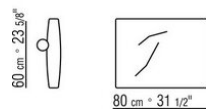

COD. 011P98 KISSEN

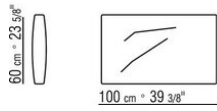

COD. 011P96 KISSEN MIT ROLLE

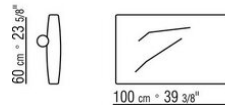

COD. 011P50 HOCKER

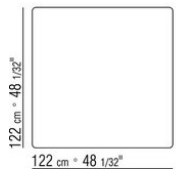
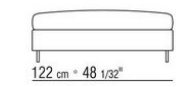

COD. 011P51 HOCKER

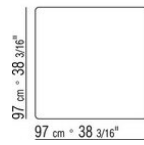
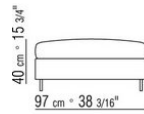

COD. 011P52 HOCKER

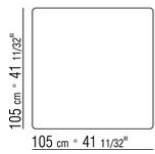
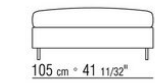

COD. 011P56 HOCKER / DACRON

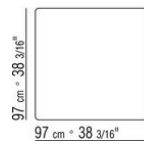
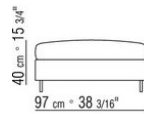

COD. 011P57 HOCKER / DACRON

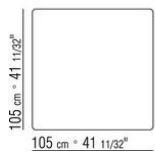
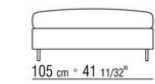

COD. 011P55 HOCKER / DACRON

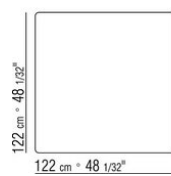
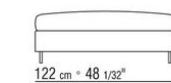

011PXA

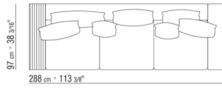

- N.1 COD.011P72 - ARMLEHNE KERNLEDER CM.97 x24
- N.1 COD.011P70 - ARMLEHNE CM.97 x24
- N.1 COD.011P04 - ELEMENT CM.240 x97
- N.1 COD.011P99 - KISSEN CM.60 x60
- N.2 COD.011P95 - KISSEN MIT ROLLE CM.60 x60
- N.1 COD.011P97 - KISSEN MIT ROLLE CM.80 x60
- N.2 COD.011P93 - KISSEN CM.40 x40
- N.1 COD.011P92 - KISSEN CM.60 x55

011PXC

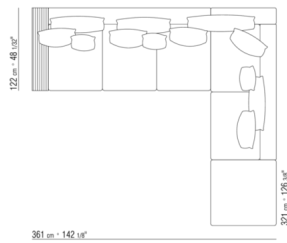

- N.1 COD.011P73 - ARMLEHNE KERNLEDER CM.122 x24
- N.1 COD.011P70 - ARMLEHNE CM.97 x24
- N.1 COD.011P06 - ELEMENT CM.240 x122
- N.1 COD.011P03 - ELEMENT CM.200 x97
- N.1 COD.011P51 - HOCKER CM.97 x97
- N.2 COD.011P99 - KISSEN CM.60 x60
- N.3 COD.011P97 - KISSEN MIT ROLLE CM.80 x60
- N.1 COD.011P96 - KISSEN MIT ROLLE CM.100 x60
- N.3 COD.011P93 - KISSEN CM.40 x40
- N.3 COD.011P92 - KISSEN CM.60 x55