

Molteni & C

GLISS MASTER — VINCENT VAN DUYSSEN 2015

1—
41



Molteni&C has extended the possibilities for Gliss Master, renewing the architectural concept of the nighttime area. The melamine offering is enriched with a new internal finish, a “White” texture, and a new warm Bronze finish, feminine and sophisticated, which represents the latest interpretation of this metal. The insides feature new accessories, such as the top of the structure which can be made of glass, to make the wardrobe even more transparent. The Master chest-of-drawers also has new tops, one made of transparent glass framed in Pewter and Bronze-coloured aluminium, which, thanks to the LED lighting, enhances the drawer inside; the other enriched with a stackable and pull-out threelayer trinket tray, which can be positioned at will. Two new options for the doors: “Swing” door, matt lacquered, which can be opened at 180°. “Twin” door, with the strong formal appeal typical of Vincent Van Duysen, with a new Pewter-coloured outer handle.

The Internet Of Things (IOT) joins the world of Molteni&C nighttime systems – Gliss Master and Master Dressing – with avant-garde solutions and innovations that guarantee wardrobes the best environmental quality. AIRCUB® – a Molteni&C exclusive – is an IOT device easily manageable from your smartphone with a dedicated APP. The air purification and perfuming system works by ionizing and ozonizing wardrobe interiors, thereby removing up to 95% of agents harmful to health, while releasing delicate fragrances.

DATASHEET

REGISTERED
DESIGN

IX.2018

moltenigroup.com

Dimensions in millimeters and inches. The right to discontinue and make changes is reserved. This information is based on the latest product information available at the time of printing.

FINISHES

Finishes components

| | | melamine structure | melamine front | mat lacquer colours | cartapaglia lacquered | glossy lacquer colours | woods | coloured glass/etched coloured glass/mirror | shiny aluminium/black chrome | pewter colour/bronze | Eco Skin | extraclear transparent glass/transparent stopsol/stopsol | fine grain |
|--|------------|--------------------|----------------|---------------------|-----------------------|------------------------|-------|---|------------------------------|----------------------|----------|--|------------|
| linear module and corner module | base/lid | | | | | | | | | | | | |
| | back panel | | | | | | | | | | | only linear | |
| wooden central partition | | | | | | | | | | | | | |
| wooden external side panel | | | | | | | | | | | | | |
| extension profile | | | | | | | | | | | | | |
| central partition or side panel frame or glass | frame | | | | | | | | | | | | |
| | glass | | | | | | | | | | | central only transparent | |
| START / TWIN door | | | | | | | | | | | | | |
| "A FILO" door | | | | | | | | | | | | | |
| "A FILO" glass door | profile | | | | | | | | | | | | |
| | glass | | | | | | | | | | | | |
| BLADE sliding door | | | | | | | | | | | | | |
| GRIP door | | | | | | | | | | | | | |
| DEEP door | | | | | | | | | | | | | |
| NICHE door | | | | | | | | | | | | | |
| GLASS door | profile | | | | | | | | | | | | |
| | glass | | | | | | | | | | | | |
| SWING door | | | | | | | | | | | | | |
| WINDOW door | profile | | | | | | | | | | | | |
| | glass | | | | | | | | | | | | |
| SKIN door | | | | | | | | | | | | | |
| | profile | | | | | | | | | | | | |
| | panel | | | | | | | | | | | | |

| | | melamine structure | melamine structure pewter colour/bronze profile | Eco Skin pewter colour/bronze profile | fine grain pewter colour/bronze profile | transparent glass | pewter colour/bronze | grey saffiano melamine | larix dark/silver cembran | mat lacquer colours | |
|---|---------|--------------------|---|---------------------------------------|---|-------------------|----------------------|------------------------|---------------------------|---------------------|--|
| internal fittings | | | | | | | | | | | |
| shelf | | | | | | | | | | | |
| wooden drawer fronts H 126/190/382 | | | | | | | | | | | |
| tray front (trouser holders/trinket trays) | | | | | | | | | | | |
| front for open drawers / pull-out trays | | | | | | | | | | | |
| glass drawer fronts/ glass shelf | profile | | | | | | | | | | |
| | glass | | | | | | | | | | |
| drawer internal | | | | | | | | | | | |
| dividing partitions - grid with shirt/sweater holders | | | | | | | | | | | |
| island drawer unit | | | | | | | | | | | |
| drawer unit | | | | | | | | | | | |

colours

Melamine structure

YB white shantung
YG grey shantung
YM larix dark
YA silver cembran
WW white

Melamine front

KA cartapaglia anthracite
KB cartapaglia white
KS cartapaglia silica
WS graffiato bronze
ZB silk chalk white
ZS silk silica
ZT silk dove grey

Matt lacquer/ Cartapaglia lacquered

BC chalk white
PE pearl
DN dune
PL platinum
NE black
AT anthracite
SE mustard
SI silica
DO dolomite grey
AL clay
MK moka
CM caramel
CZ light blue grey
SA sand
RU ruby
RE rust
PX pewter colour
RX copper
TO dove grey

Glossy lacquer

BC chalk white
PE pearl
DN dune
PL platinum
NE black
AT anthracite
SE mustard
SI silica
DO dolomite grey
AL clay
MK moka
CM caramel
CZ light blue grey
SA sand
RU ruby
RE rust
PX pewter colour
RX copper
TO dove grey

Coloured glass

BC chalk white
PE pearl
DN dune
PL platinum
NE black
AT anthracite
SE mustard
SI silica
DO dolomite grey
AL clay
MK moka
CM caramel
CZ light blue grey
SA sand
RU ruby
RE rust
PX pewter colour
RX copper
TO dove grey

Etched coloured glass

BC chalk white
PE pearl
DN dune
PL platinum
NE black
AT anthracite
SE mustard
SI silica
DO dolomite grey
AL clay
MK moka
CM caramel
CZ light blue grey
SA sand
RU ruby
RE rust
PX pewter colour
RX copper
TO dove grey

Woods

EU eucalyptus
RG grey oak
RF graphite oak

Eco Skin

grey
mink
hemp
ivory
dark brown

Molteni & C

DATASHEET

REGISTERED
DESIGN

IX.2018

TECHNICAL INFORMATION

STRUCTURE

BASE

Wooden particleboard panel faced with melamine and adjustable feet in contact with the ground.

COVER, PARTITION AND BACK PANEL

Wooden particleboard panel faced with melamine. The partitions are provided with adjustable feet in contact with the ground.

FINE GRAIN BACK PANEL

Chipboard coated with cylinder etched coextruded sheet of ABS-PMMA, painted in specific Molteni finish.

BACK PANEL, LID, SIDE PANEL AND CENTRAL PARTITION (GLASS)

Frame perimeter in painted extruded aluminium with 4 mm tempered glass. Available in different finishes.

SIDE PANEL (MELAMINE)

Wooden particleboard panel faced with melamine. Adjustable feet in contact with the ground.

SIDE PANEL (MATT OR GLOSSY LACQUERED IN THE COLOURS)

Wooden particleboard panel faced with melamine. Outside painted in the colours of the "Molteni Range". Adjustable feet in contact with the ground.

SIDE PANEL (WOOD)

Wooden particleboard panel with inner melamine facing and outer facing with sliced Oak (Quercus) or Eucalyptus (Eucalyptus globulus). Adjustable feet in contact with the ground.

CENTRAL FRAME PARTITION

Frame perimeter in painted extruded aluminium.

COVERING PROFILES AND RUNNERS

Extruded aluminium covered with melamine facing or painted, with dust-proof seals.

FRONT EDGING

Anodised extruded aluminium, lacquered in the "Molteni Range" colours or faced with sliced Oak or Eucalyptus.

DOORS

MELAMINE (START - TWIN - "A FILO" - BLADE - GRIP - DEEP)

Wooden particleboard panel faced with melamine. Cushioned hinges and sliding system. Handles in various materials and finishes.

MATT OR GLOSSY LACQUERED IN THE COLOURS (START - "A FILO" - BLADE - GRIP - DEEP - NICHE - SWING)

Wooden particleboard panel faced with melamine, painted in the colours of the "Molteni Range". Cushioned hinges and sliding system. Handles in various materials and finishes. For the SWING model, the panel is trimmed using a painted aluminium extrusion.

WOOD (START - TWIN - "A FILO" - BLADE - GRIP - DEEP - NICHE)

Wooden particleboard panel faced with sliced Oak or Eucalyptus. Handles in various materials and finishes.

GLASS HINGED DOOR ("A FILO")

Wooden particleboard panel faced with melamine, with a 5-mm-thick glass panel or mirror applied, painted in the colours of the "Molteni Range". Outer frame profile of anodised extruded aluminium. Cushioned hinges.

GLASS SLIDING DOOR ("A FILO")

Frame in anodised extruded aluminium with mounted mirror or 5 mm glass, painted in "Molteni Range" colours. Sliding system with shock absorbers.

GLASS doors

Extruded aluminium frame with 4 mm glass available in different finishes. Recessed hinges with 180° opening.

WINDOW doors

Frame in painted extruded aluminium with 5 mm glass available in different finishes. Recessed soft close hinges.

SKIN doors

Frame in painted extruded aluminium with honeycomb panel inserted and covered in eco-leather. Recessed soft close hinges.

DATASHEET

REGISTERED
DESIGN

IX.2018

TECHNICAL INFORMATION

INTERNAL FITTINGS

PULL-OUT SHIRT HOLDER
 Painted parts made using a phenolic laminated panel. Front tray made of woodchip board faced with melamine. Bottom clad in eco-leather

DRAWER UNIT STRUCTURE FOR FRAME SIDES
 Chipboard panel with melamine facing, painted in specific Molteni finish.

INNER SHELVES, DRAWER OR TRAY FRONT, MOVABLE TRAYS SET AND GRID WITH SHIRT AND SWEATER HOLDERS
 Wooden particleboard panel faced with melamine.

INNER SHELVES WITH FRONT PROFILE
 Chipboard panel covered with melamine facing, front profile in painted extruded aluminium.

INNER SHELVES IN ECO SKIN
 Chipboard panel covered with melamine facing, front profile in painted extruded aluminium and upper covering in eco-leather.

CLOTHES RODS
 Anodised aluminium rod. Tube support of chrome-plated plastic material.

GLASS FRONT PANEL AND GLASS SHELVES
 In painted or extruded aluminium. 4-mm-thick tempered glass.

FINE GRAIN FRONT
 Chipboard panel covered with cylinder etched coextruded sheet of ABS-PMMA, painted in specific Molteni finish. Perimeter profile in painted extruded aluminium.

DRAWER AND TRAY INNER SIDES
 Wooden particleboard panel faced with melamine.

DRAWER AND TRAY INNER BOTTOM
 Wooden particleboard panel faced with melamine.

SHOE RACK AND TROUSER RACK PROFILES
 In anodised or painted aluminium extrusion.

PULL-OUT MIRROR
 Metal frame with mirror 4 mm th.

HANDLES AND VARIOUS ACCESSORIES
 In various materials and finishes.

BASE, TOP AND SHELVES IN WOOD (ISLAND WITH GLASS DOORS)
 Chipboard panel covered with wood veneer in Eucalyptus or Oak.

IONISER
 See technical sheet enclosed with the product.

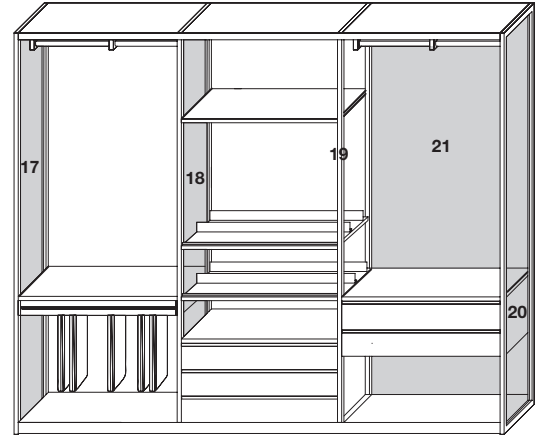
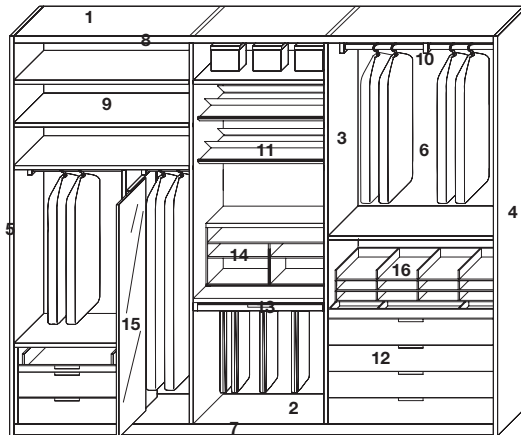

- 1 Top
- 2 Base
- 3 Partition
- 4 Side
- 5 Extension profile
- 6 Back
- 7 Covering profile or bottom runner
- 8 Covering profile or top runner
- 9 Shelf th. 30
- 10 Clothes rails
- 11 Shoe rack shelf
- 12 Drawers
- 13 Trouser holder - trinket trays
- 14 Grid with shirt and sweater holders
- 15 Pull-out mirror
- 16 Pull-out shirt holder

- 17 Side glass panel
- 18 Central glass partition
- 19 Central frame partition
- 20 Drawer unit structure
- 21 Glass back panel

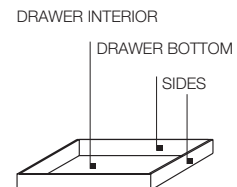

DATASHEET

REGISTERED
 DESIGN

IX.2018

MODULARITY

Modularity - Structure

The widths 492 - 656 - 820 - 984 - 1312 - 464 (term. element) mm (19 3/8" - 25 7/8" - 32 1/4" - 38 3/4" - 51 5/8" - 18 1/4") include the left side panel. The total width of the composition will include the final panel of th. 30 mm (1 1/8").
 Heights: tot. H 2343 (92 1/4"), door 2313 (91"), int.2253 (87 3/4"), sliding or flush sl. door inter. 2163 (85 1/8")
 tot. H 2439 (96"), door 2409 (94 7/8"), int. 2349 (92 1/2"), sliding or flush sl. door inter. 2259 (88 7/8")
 tot. H 2631 (103 5/8"), door 2601 (102 3/8"), int. 2541 (100"), sliding or flush sl. door inter. 2451 (96 1/2")
 tot. H 2919 (114 7/8"), door 2889 (113 3/8"), interior 2829 (111 3/8"), only hinged

Assembly instructions

For the assembling of a sliding and a flush sliding door wardrobe a minimum space of 6 cm (2 3/8") is required considering the minimum height of the compartment.
 Assembly of the corner element (for wardrobe with doors) requires a minimum extra height of 6 cm (2 3/8").
 Assembly of a wardrobe in an alcove requires a minimum extra side space of 4 cm (1 5/8").
 A wardrobe with hinged doors and a lighting system requires a minimum extra height of 5 cm (2").

Molteni&C

5—
41

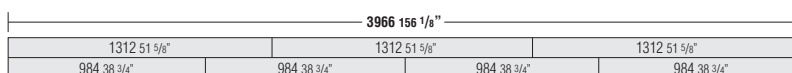
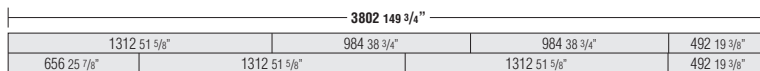
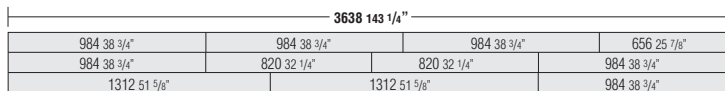
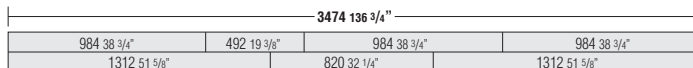
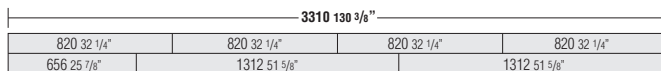
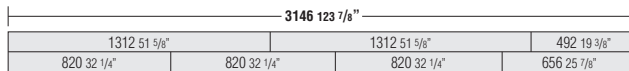
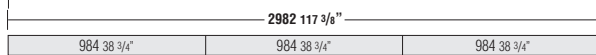
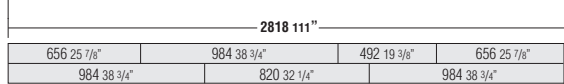
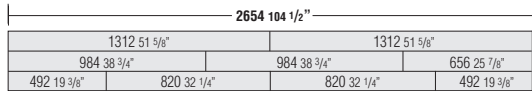
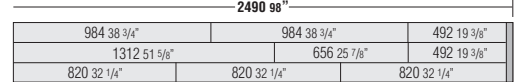
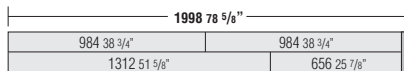
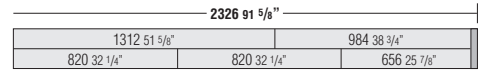
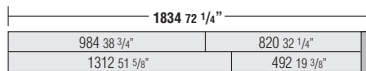
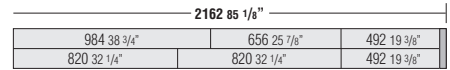
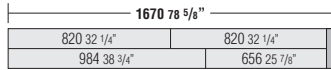
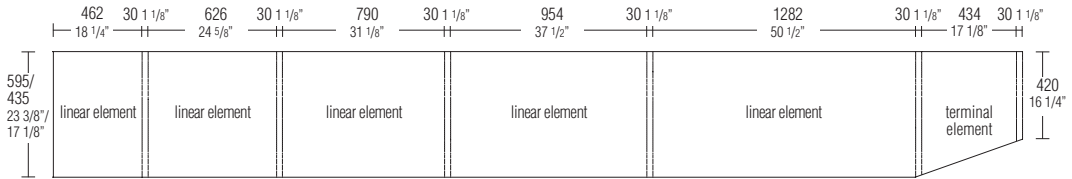

DATASHEET

REGISTERED
DESIGN

IX.2018

DOORS

START-TWIN hinged doors
applicable only on structures
with wood sides

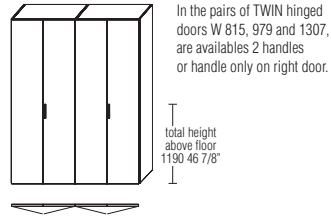

In the pairs of TWIN hinged doors W 815, 979 and 1307, are availables 2 handles or handle only on right door.

The pairs of hinged doors START and "A FILO" always have a handle mounted on the right door.

"A FILO" hinged doors
applicable only on structures
with wood sides

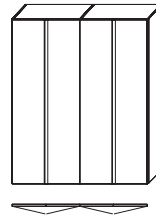

DEEP-GRIP hinged doors
applicable only on structures
with wood sides

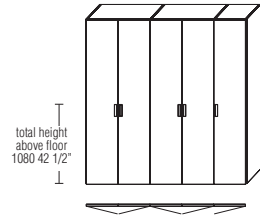

NICHE doors
applicable only on structures
with wood sides

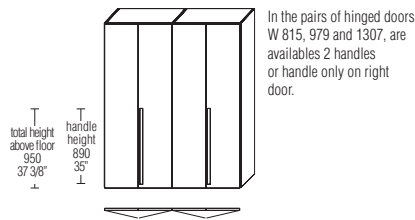

In the pairs of hinged doors W 815, 979 and 1307, are availables 2 handles or handle only on right door.

WINDOW - SKIN door
applicable on all types
of structures

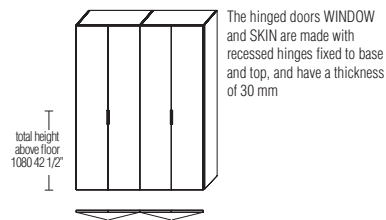

The hinged doors WINDOW and SKIN are made with recessed hinges fixed to base and top, and have a thickness of 30 mm

GLASS-SWING doors, th 35
applicable on all types
of structures

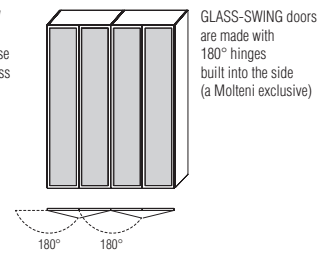

GLASS-SWING doors are made with 180° hinges built into the side (a Molteni exclusive)

Sliding doors

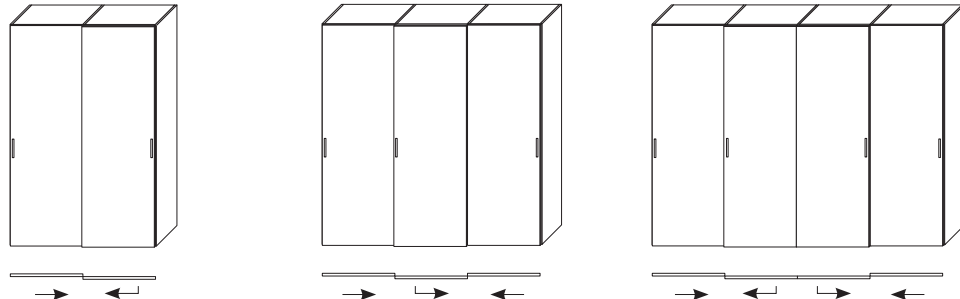

It is possible to make sliding door wardrobes with doors of the following types:

- START
- "A FILO"
- GRIP
- DEEP
- BLADE

It is possible to make the external sliding door with two handles if using the "A FILO" or BLADE door (full-height handle) and applying the surcharge

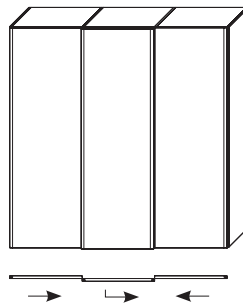

Detail of side panel with extension profile

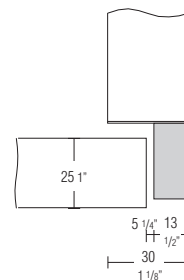

with BLADE door

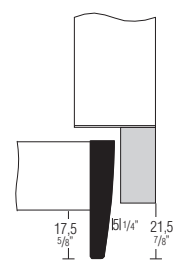

Flush sliding doors

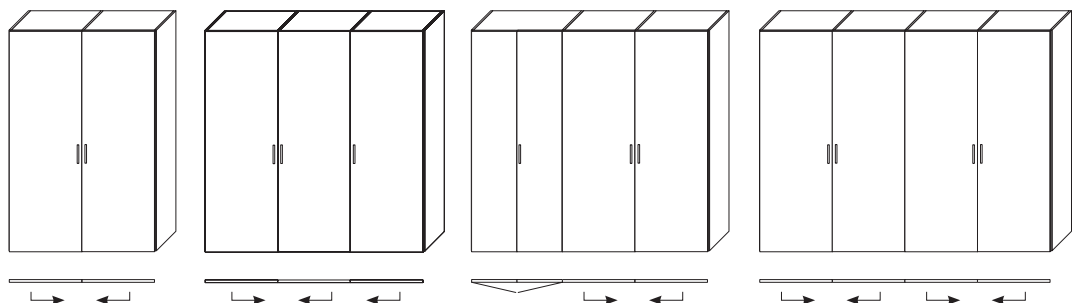

DATASHEET

REGISTERED
DESIGN

IX.2018

DOORS

155° opening (only for compartments with wooden sides)

On **START - TWIN - "A FILO" - GRIP - DEEP - NICHE** doors it is also possible to use **155° opening hinges, with an extra charge per individual door**. In this case, it is necessary to take special care in inserting internal drawer units, trinket trays and devices.

It is also necessary to comply with the diagrams provided here.

Molteni & C

7—
 41

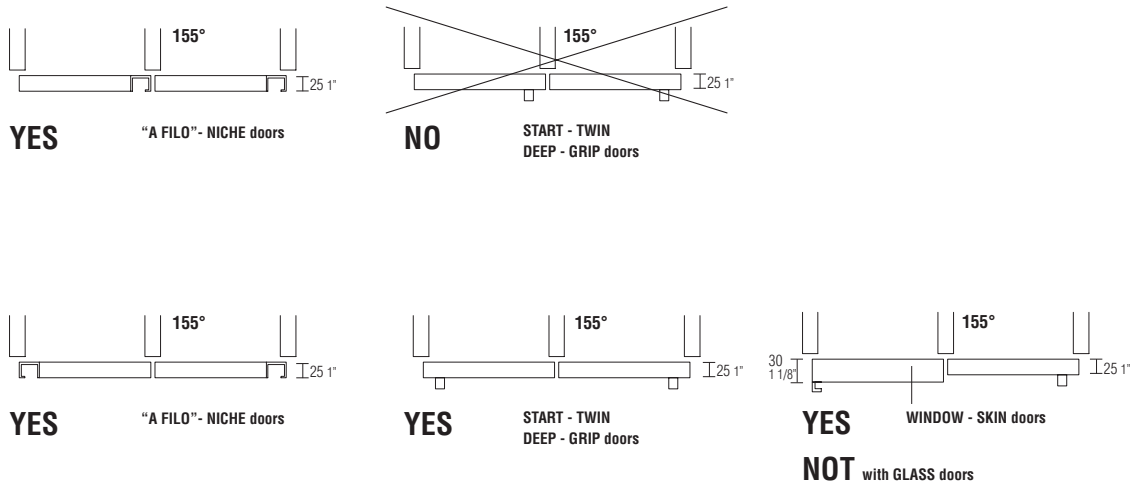

Hinged doors with key lock

For the hinged doors specified, a key lock can be fitted to order. There is an additional cost for one or two doors. It can even be fitted on a terminal element or a corner element (in compliance with the handle installation rules). For doors with a lock, the internal drawer units must be suspended. Installation of only the lock can be requested, without a handle, always considering the price of the START doors and the additional cost of the lock.

START door handle type "M"

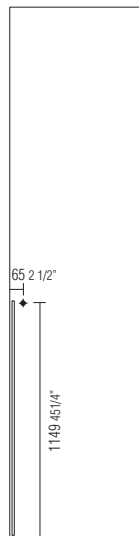

START door handle type "E"

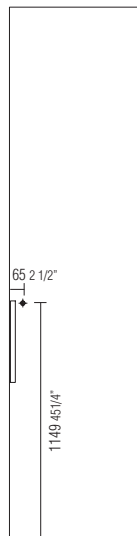

"A FILO" door

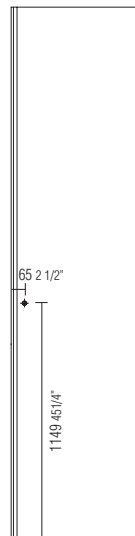

DATASHEET

REGISTERED
 DESIGN

IX.2018

CORNER ELEMENT

Corner element D 595 - open or with GLASS/SWING doors

The corner element is provided complete with a base, lid and backs (melamine or fine grain). Between the corner element and the adjacent modules, it is necessary to insert central partitions in melamine, frame or glass.

The corner element can also receive a side panel to close the composition. Compartments adjacent to the closed corner element can be open or closed with GLASS or SWING doors.

Notes

The shelf is not included in the price of the corner element. Shelves and lids can be fitted with LED lighting bars, as indicated in the drawing below.

Reductions

The corner element can be reduced in height, width and depth. In width, the reduction can be carried out either on one side only or on both sides, up to a minimum width of 1101 mm.

Reduction in depth can be done on one or on two sides, up to a minimum of 435 mm. If only one side is reduced, that will be the side with the longest shelves (*).

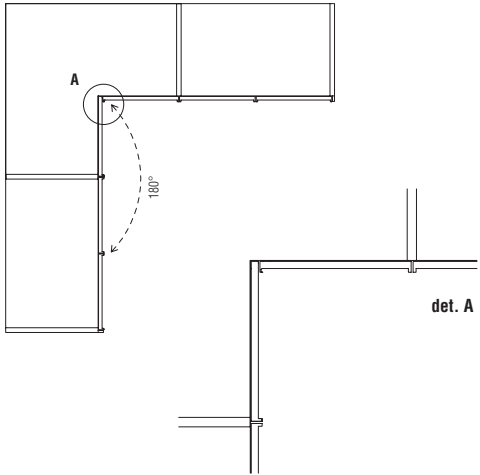
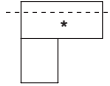

Molteni & C

8—
 41

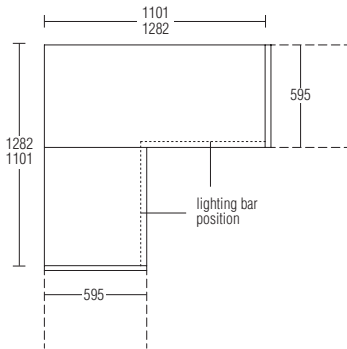
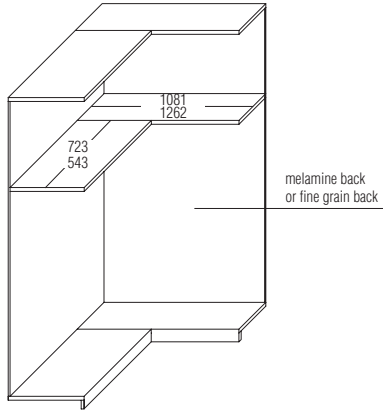

The corner element can be fitted with shelves and clothes rails, or with this solution of drawer units that have a central partition H 1158 where the desired drawer unit can be inserted. The drawer unit can be with fronts W 420 or 584.

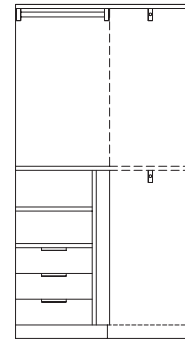
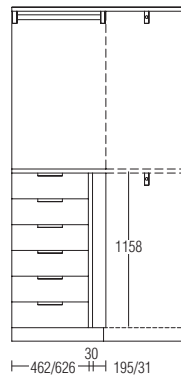
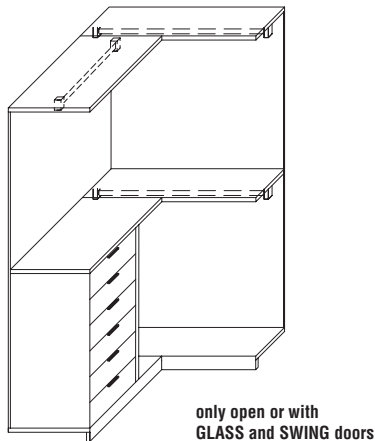

No type of drawer unit can be inserted with frame or glass sides

DATASHEET

REGISTERED
 DESIGN

IX.2018

STRUCTURE

Structure for walk-in closet

In version **A**, the structure (base, lid, central partitions, back and side panels) is in melamine, in the same finish as the structure.

The back piece can also be provided in fine grain finish.

The side panels are always provided without extension profile (see detail).

In version **B**, the central partitions and sides are made with an aluminium frame with pewter colour or bronze finish, with or without glass.

Base, lid and back piece are in melamine, in the same finish as the structure.

The back piece can also be provided in fine grain or glass finish.

Horizontal tags on the base and lid are made in a pewter colour or bronze finish like the side frames.

In version **C**, given the presence of frame sides in pewter colour finish, the central and side partitions in melamine are also made with from tags in pewter colour or bronze, considering the specific price.

Molteni & C

9—
 41

version A - Structure with wooden sides (melamine in the same colour as the structure)

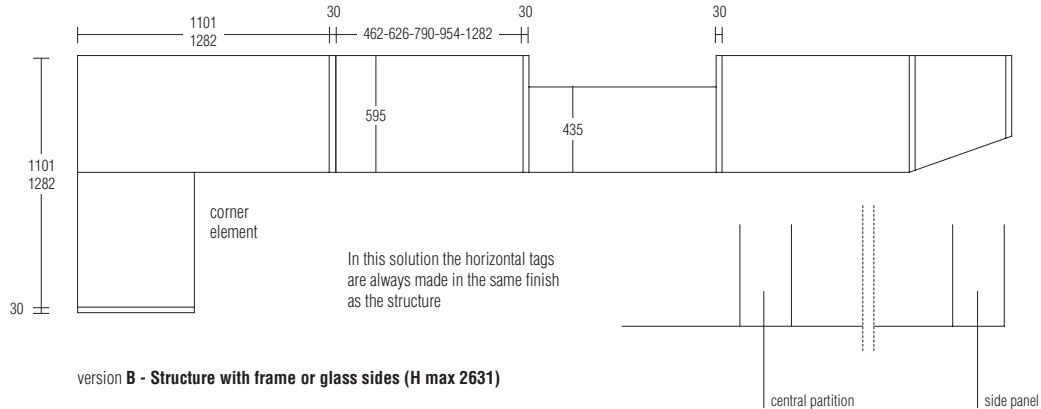

version B - Structure with frame or glass sides (H max 2631)

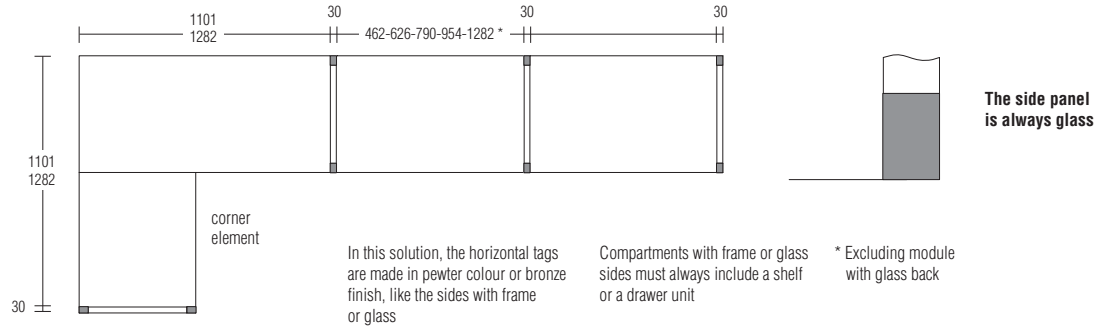

version C - Structure with mixed sides (H max 2631)

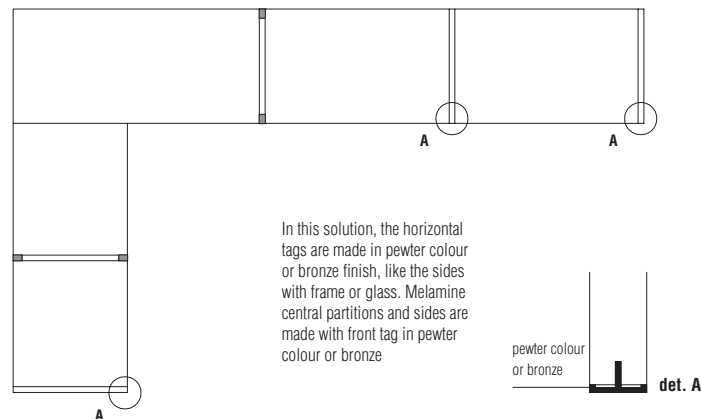

DATASHEET

REGISTERED
 DESIGN

IX.2018

STRUCTURE

Linear modules

Linear modules are made up of a base and lid always made in melamine in the same finish as the structure.

The back is available in the three versions indicated below.

A1 and **A2** can be reduced in height, width and depth if closed by sides and doors that are compatible with the requested reductions.

A3 can be reduced only in height.

Central partitions

These are available in melamine, in the same finishes as the structure, frame and glass.

The melamine version can be reduced in height and depth.

The frame and glass versions can be reduced only in height.

Compartments with frame or glass sides must always include a shelf or a drawer unit.

Side panels

These are available in melamine, in the same finishes as the structure, frame and glass. The melamine version can be reduced in height and depth.

The outside of the side panel is available in the matt lacquer, glossy lacquer or wooden (vertical grain) finishes.

The standard finish on side panels is an extension profile in the coloured matt lacquer, pewter colour, bronze, shiny aluminium or black chrome finishes (to be specified in the Order). The extension profiles for glossy lacquer or wood side panels always match the side panels of the same finish.

The frame and glass versions can be reduced only in height.

Compartments with frame or glass sides must always include a shelf or a drawer unit.

Molteni & C

10—
41

A1 - Melamine back

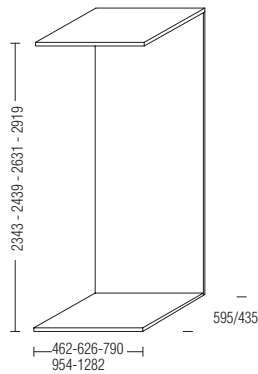

A1
Base, lid and back made in melamine finish matching the structure

A2 - Fine grain back

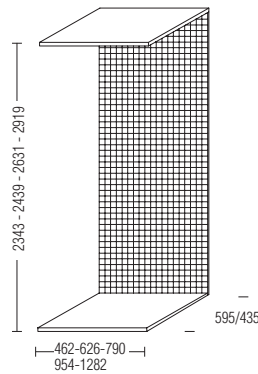

A2
Base and lid made in melamine finish matching the structure. Back with fine grain finish

A3 - Glass back

(only hinged GLASS, WINDOW and closet)

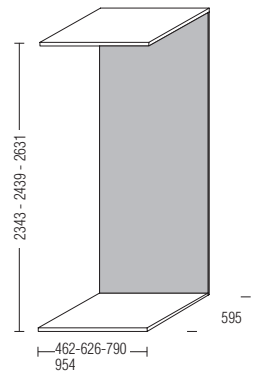

A3
Base and lid made in melamine finish matching the structure. Back in glass, **only made with frame and glass sides.** It is possible to produce single finished modules W 790/954 with lateral pieces in glass by using the glass lids

Central partitions, th 30

Warning:

frame sides and glass sides will only have holes at the position of the shelves. Complete hole series at regular intervals 96 mm will involve an extra charge per side.

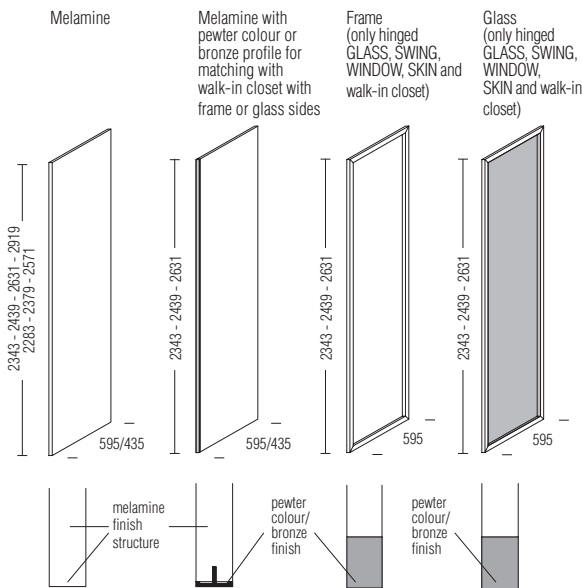

Side panels, th 30

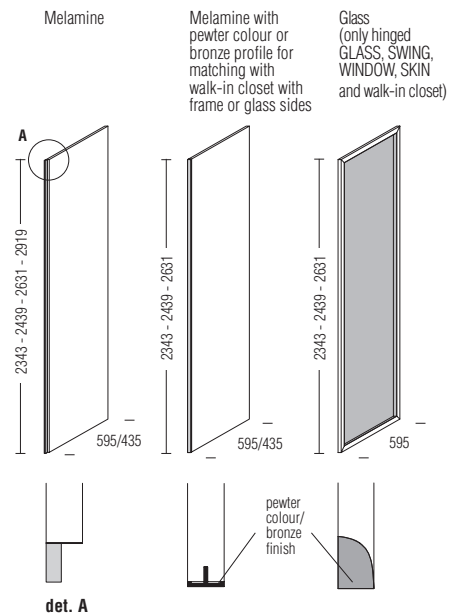

DATASHEET

REGISTERED
DESIGN

IX.2018

WARDROBE REDUCTIONS

Structure reductions

| Type of reduction | height | width | depth |
|--|----------------|---------------------------|--|
| Linear modules D 595 mm melamine back or fine grain back | per millimetre | per millimetre | min -20 mm max -256 wardrobe / flush sliding ward. max -160 mm |
| Linear modules D 595 mm glass back | per millimetre | no reductions | no reductions |
| Linear elements D 435 mm | per millimetre | per millimetre | min -20 mm max -96 mm |
| Corner element for wardrobe with doors | per millimetre | no reductions | no reductions |
| Corner element open or for GLASS/SWING doors | per millimetre | 1 side up to 1101 x 1282 | 1 side up to mm 435 |
| | | 2 sides up to 1101 x 1101 | 2 sides up to mm 435 |
| Terminal element | per millimetre | no reductions | no reductions |
| Wooden central partition or side panel | per millimetre | | reductions depend on linear modules |
| Frame or glass side panel or central partition | per millimetre | | no reductions |

The retailer should remember to verify the stability of wardrobes having a depth inferior to 595 mm and arrange to have anti-tilt devices mounted if necessary.

Door reductions

| Type of reduction | height | width |
|--|----------------|---|
| Wooden hinged doors (START - TWIN - "A FILO" - GRIP - DEEP - NICHE) | per millimetre | per millimetre |
| "A FILO" glass hinged doors | per millimetre | per millimetre |
| Wooden sliding doors (START - "A FILO" - BLADE - GRIP - DEEP) | per millimetre | ONLY doors W 979 and 1307 mm - reducible down to W 815 mm |
| "A FILO" glass sliding doors | per millimetre | no reductions |
| Wooden flush sliding doors (START - TWIN - "A FILO" - GRIP - DEEP) Flush sliding doors W 1471 mm cannot be reduced. | per millimetre | no reductions |
| "A FILO" glass flush sliding doors | per millimetre | no reductions |
| SKIN doors | no reductions | no reductions |
| WINDOW / GLASS / SWING doors | per millimetre | reducible down to W 405 mm |

Reductions of internal fittings

| Type of reduction | height | width | depth |
|--|-----------------|----------------|-------------------------------------|
| Wood shelves | | per millimetre | reductions depend on linear modules |
| Shelves with pewter colour profile | | per millimetre | reductions depend on linear modules |
| Eco Skin shelves | | per millimetre | reductions depend on linear modules |
| Glass shelves | | per millimetre | reductions depend on linear modules |
| Clothes rails | | per millimetre | |
| Central divider pieces | 32 mm intervals | | reductions depend on linear modules |
| Internal drawers / trinket trays, trouser holders and pull-out trays / grid with shirt and sweater holders / shoe rack shelves / pull-out shirt holders / lighting shelves / islands / movable trays | no reductions | no reductions | no reductions |

* If the corner shelves are reduced on two sides, consider double the cost.
Lighting bars can be reduced with a surcharge included in the fee for cutting the shelf.

Cuts to measure

Diagonal cut doors (only for wardrobes with wooden sides)

When compiling the order, indicate the heights H1 and H2 and the width L as in the example.

The cost of a diagonal cut for each single door is the same as that for the hinged door in the table on page of the doors.

Compositions with diagonal slant are always built with single-door compartments. Only fitted with START, TWIN, "A FILO", GRIP or DEEP hinged doors. Doors must be hinged to the highest side panel. The door finish options for slanted wardrobes are restricted to cartapaglia, matt lacquer and matt lacquered cartapaglia. Structures can be either in standard sizes or customised.

Standard or cut-to-size doors (only for wardrobes with wooden sides)

For these solutions you can use either single or double units with hinged doors.

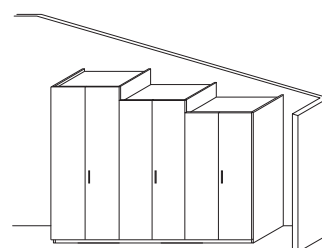
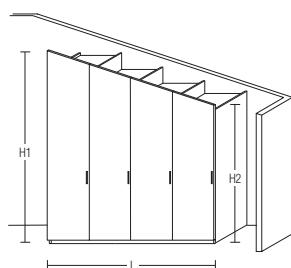

DATASHEET

REGISTERED
DESIGN

IX.2018

GLISS
MASTER—
VINCENT
VAN DUYSSEN
2015

GLASS TOP FOR WARDROBES FINISHED WITH ONLY ONE COMPARTMENT W 790/954

To use only with:
- single linear module W 790 / W 954
(no modular arrangement is possible)
- only with glass lateral pieces and glass back panel
- clothes rod cannot be mounted on the lid

Glass finish
transparent glass
transparent stopsol glass
stopsol glass

Profile finish
pewter colour
bronze

Molteni & C

12—
41

Increase valid for depths 595 - 23 3/8"

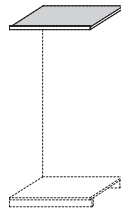

W 790 - 31 1/8"

W 954 - 37 1/2"

DATASHEET

REGISTERED
DESIGN

IX.2018

moltenigroup.com

Dimensions in millimeters and inches. The right to discontinue and make changes is reserved. This information is based on the latest product information available at the time of printing.

START door th 25

Door with handles mounted on the front.

All the hinged doors have cushion-closing hinges.
The sliding door have a shock absorber mechanism which allows them to open and close softly.
Hinges with 155° opening can be used and a key lock can be installed on hinged doors.

Handles

Type "E"
Type "M"

Notes

Sliding doors and flush sliding doors are not available in H 2889.

With fronts in cartapaglia melamine, graffiato, silk and lacquered cartapaglia finishes, the outside of the side panel can be made with matt lacquer finish (in the same colour as the front), or in melamine in the same finish as the inside structure (if the side panel is not visible).

Molteni & C

13 —
41

START door

melamine cartapaglia
melamine graffiato
melamine silk
matt lacquer colours
cartapaglia lacquered colours
glossy lacquer colours
vertical grain wood

Type "E"

standard

Pewter colour structure with front insert:

pewter colour
matt lacquer colours
woods
coloured glass
etched coloured glass

Structure and front insert:

shiny aluminium
black chrome
bronze

Type "M"

surcharge for each

Finish

pewter colour
shiny aluminium
black chrome
bronze

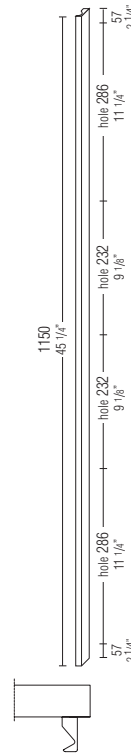
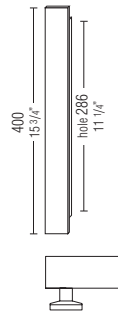
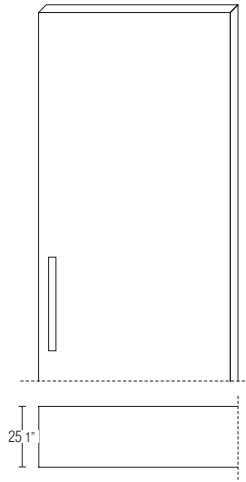

finishes

melamine front matt lacquer colours cartapaglia lacquered colours vertical grain wood glossy lacquer colours

hinged doors

| | | | | | |
|---------------------------|--|--|--|--|--|
| width 487 (19 1/8") | | | | | |
| width 651 (25 5/8") | | | | | |
| width 815 (32 1/8") | | | | | |
| width 979 (38 1/2") | | | | | |
| width 1307 (51 1/2") | | | | | |
| door for terminal element | | | | | |

sliding doors

| | | | | | |
|----------------------|--|--|--|--|--|
| width 815 (32 1/8") | | | | | |
| width 979 (38 1/2") | | | | | |
| width 1307 (51 1/2") | | | | | |
| width 1471 (57 7/8") | | | | | |

flush sliding doors

| | | | | | |
|----------------------|--|--|--|--|--|
| width 815 (32 1/8") | | | | | |
| width 979 (38 1/2") | | | | | |
| width 1307 (51 1/2") | | | | | |
| width 1471 (57 7/8") | | | | | |

DATASHEET

REGISTERED
DESIGN

IX.2018

TWIN door th 25

Door with pewter colour or bronze finish handle mounted on the front.

All the hinged doors have cushion-closing hinges. The sliding door have a shock absorber mechanism which allows them to open and close softly.

Hinges with 155° opening can be used and a key lock can be installed on hinged doors.

Notes

Flush sliding doors are not available in H 2889.

With fronts in cartapaglia melamine, graffiato, silk and lacquered cartapaglia finishes, the outside of the side panel can be made with matt lacquer finish (in the same colour as the front), or in melamine in the same finish as the inside structure (if the side panel is not visible).

Molteni & C

14—
41

TWIN door

melamine cartapaglia
melamine graffiato
melamine silk
matt lacquer colours
cartapaglia lacquered colours
glossy lacquer colours
vertical grain wood

Handle finish

pewter colour
bronze

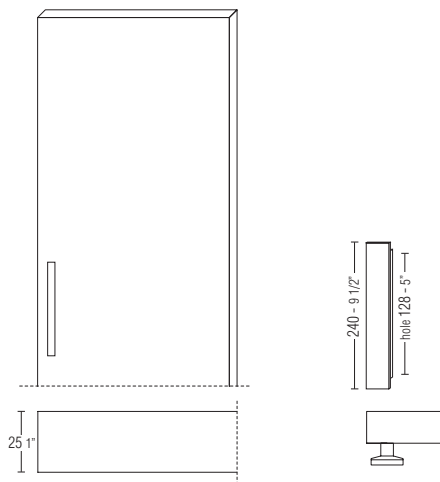

finishes

melamine front matt lacquer colours cartapaglia lacquered colours vertical grain wood glossy lacquer colours

hinged doors

| | | | | | |
|---------------------------|--|--|--|--|--|
| width 487 (19 1/8") | | | | | |
| width 651 (25 5/8") | | | | | |
| width 815 (32 1/8") | | | | | |
| width 979 (38 1/2") | | | | | |
| width 1307 (51 1/2") | | | | | |
| door for terminal element | | | | | |

flush sliding doors

| | | | | | |
|----------------------|--|--|--|--|--|
| width 815 (32 1/8") | | | | | |
| width 979 (38 1/2") | | | | | |
| width 1307 (51 1/2") | | | | | |
| width 1471 (57 7/8") | | | | | |

DATASHEET

REGISTERED
DESIGN

IX.2018

“A FILO” door th 25

Door with full-height handle included in the thickness of the door.
 The door is available in the versions wood and glass.

All the hinged doors have cushion-closing hinges.
 The sliding door have a shock absorber mechanism which allows them to open and close softly.
Hinges with 155° opening can be used and a key lock can be installed on hinged doors.

Notes

Sliding doors and flush sliding doors are not available in H 2889.
 Glass hinged doors are not available in H 2889.
 Flush sliding glass doors cannot be used in compositions with 3 doors.

With fronts in cartapaglia melamine, graffiato, silk and lacquered cartapaglia finishes, the outside of the side panel can be made with matt lacquer finish (in the same colour as the front) or in melamine in the same finish as the inside structure (if the side panel is not visible).

Molteni & C

15—
 41

“A FILO” wooden door

- melamine cartapaglia
- melamine graffiato
- melamine silk
- matt lacquer colours
- cartapaglia lacquered colours
- glossy lacquer colours
- vertical grain wood

“A FILO” glass door

- Glass:
- coloured
- etched coloured
- mirror

- Profile and “a filo” handle:
- pewter colour
- bronze

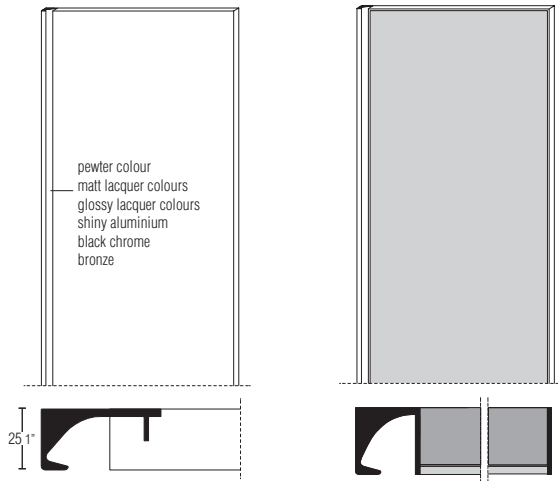

finishes

| | melamine front | matt lacquer colours | cartapaglia lacquered colours | vertical grain wood | glossy lacquer colours | coloured glass/ etched coloured glass/ mirror |
|----------------------------|----------------|----------------------|-------------------------------|---------------------|------------------------|---|
| hinged doors | | | | | | |
| width 487 (19 1/8") | | | | | | |
| width 651 (25 5/8") | | | | | | |
| width 815 (32 1/8") | | | | | | |
| width 979 (38 1/2") | | | | | | |
| width 1307 (51 1/2") | | | | | | |
| door for terminal element | | | | | | |
| sliding doors | | | | | | |
| width 815 (32 1/8") | | | | | | |
| width 979 (38 1/2") | | | | | | |
| width 1307 (51 1/2") | | | | | | |
| width 1471 (57 7/8") | | | | | | |
| flush sliding doors | | | | | | |
| width 815 (32 1/8") | | | | | | |
| width 979 (38 1/2") | | | | | | |
| width 1307 (51 1/2") | | | | | | |
| width 1471 (57 7/8") | | | | | | |

DATASHEET

REGISTERED
 DESIGN

IX.2018

BLADE sliding door th 25

Door with full-height handle.

The sliding system automatically aligns the door as it opens and closes.

Notes

BLADE doors are not available with H 2889.

With fronts in cartapaglia melamine, graffiato, silk and lacquered cartapaglia finishes, the outside of the side panel can be made with matt lacquer finish (in the same colour as the front), or in melamine in the same finish as the inside structure (if the side panel is not visible).

Molteni & C

16—
 41

BLADE sliding door
 melamine cartapaglia
 melamine graffiato
 melamine silk
 matt lacquer colours
 cartapaglia lacquered colours
 glossy lacquer colours
 vertical grain wood

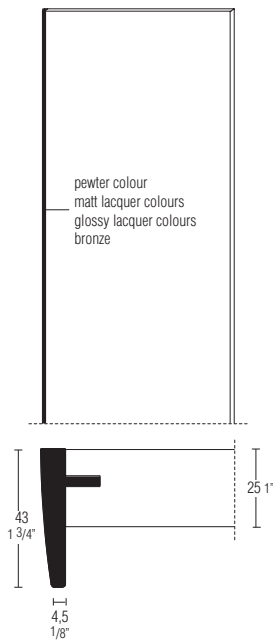

finishes

| | melamine front | matt lacquer colours | cartapaglia lacquered colours | vertical grain wood | glossy lacquer colours |
|----------------------|----------------|----------------------|-------------------------------|---------------------|------------------------|
| sliding doors | | | | | |
| width 815 (32 1/8") | | | | | |
| width 979 (38 1/2") | | | | | |
| width 1307 (51 1/2") | | | | | |
| width 1471 (57 7/8") | | | | | |

DATASHEET

REGISTERED
 DESIGN

IX.2018

GRIP door th 25 DESIGN VINCENT VAN DUYSSEN

Door with a handle applied laterally on the edge of the door.

All the hinged doors have cushion-closing hinges.
The sliding door have a shock absorber mechanism which allows them to open and close softly.
Hinges with 155° opening can be used on hinged doors.

Notes

Sliding doors and flush sliding doors are not available in H 2889.

In the pair of hinged doors, the handle is mounted on both doors in the pair.

With fronts in cartapaglia melamine, graffiato, silk and lacquered cartapaglia finishes, the outside of the side panel can be made with matt lacquer finish (in the same colour as the front), or in melamine in the same finish as the inside structure (if the side panel is not visible).

Handles finishes

pewter colour
bronze
pewter colour covered in Eco Skin in the colours (with surcharge per handle)
bronze covered in Eco Skin in the colours (with surcharge per handle)

Molteni & C

17—
41

GRIP door
melamine cartapaglia
melamine graffiato
melamine silk
matt lacquer colours
cartapaglia lacquered colours
glossy lacquer colours
vertical grain wood

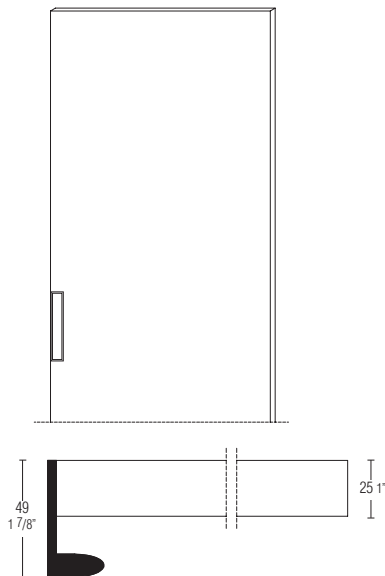

finishes

| | melamine front | matt lacquer colours | cartapaglia lacquered colours | vertical grain wood | glossy lacquer colours |
|----------------------------|----------------|----------------------|-------------------------------|---------------------|------------------------|
| hinged doors | | | | | |
| width 487 (19 1/8") | | | | | |
| width 651 (25 5/8") | | | | | |
| width 815 (32 1/8") | | | | | |
| width 979 (38 1/2") | | | | | |
| width 1307 (51 1/2") | | | | | |
| door for terminal element | | | | | |
| sliding doors | | | | | |
| width 815 (32 1/8") | | | | | |
| width 979 (38 1/2") | | | | | |
| width 1307 (51 1/2") | | | | | |
| width 1471 (57 7/8") | | | | | |
| flush sliding doors | | | | | |
| width 815 (32 1/8") | | | | | |
| width 979 (38 1/2") | | | | | |
| width 1307 (51 1/2") | | | | | |
| width 1471 (57 7/8") | | | | | |

DATASHEET

REGISTERED
DESIGN

IX.2018

DEEP door th 25 DESIGN VINCENT VAN DUYSSEN

Door with recessed handle.

All the hinged doors have cushion-closing hinges.
The sliding door have a shock absorber mechanism which allows them to open and close softly.
Hinges with 155° opening can be used on hinged doors.

Notes

Sliding doors and flush sliding doors are not available in H 2889.

In the pair of hinged doors, the handle is mounted on both doors in the pair.

With fronts in cartapaglia melamine, graffiato, silk and lacquered cartapaglia finishes, the outside of the side panel can be made with matt lacquer finish (in the same colour as the front) or in melamine in the same finish as the inside structure (if the side panel is not visible).

Handles finishes

pewter colour
bronze
pewter colour covered in Eco Skin in the colours (with surcharge per handle)
bronze covered in Eco Skin in the colours (with surcharge per handle)

Molteni & C

18—
41

DEEP door
melamine cartapaglia
melamine graffiato
melamine silk
matt lacquer colours
cartapaglia lacquered colours
glossy lacquer colours
vertical grain wood

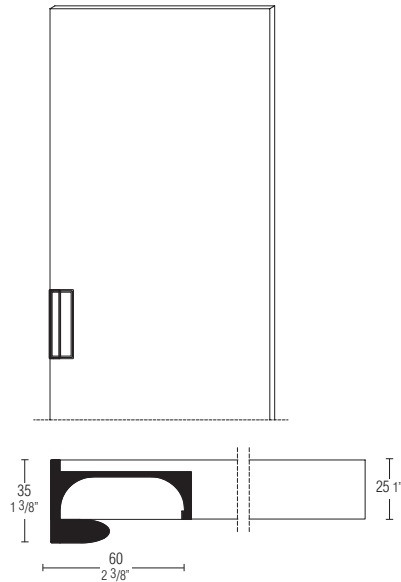

finishes

| | melamine front | matt lacquer colours | cartapaglia lacquered colours | vertical grain wood | glossy lacquer colours |
|---------------------------|----------------|----------------------|-------------------------------|---------------------|------------------------|
| hinged doors | | | | | |
| width 487 (19 1/8") | | | | | |
| width 651 (25 5/8") | | | | | |
| width 815 (32 1/8") | | | | | |
| width 979 (38 1/2") | | | | | |
| width 1307 (51 1/2") | | | | | |
| door for terminal element | | | | | |

sliding doors

| | | | | | |
|----------------------|--|--|--|--|--|
| width 815 (32 1/8") | | | | | |
| width 979 (38 1/2") | | | | | |
| width 1307 (51 1/2") | | | | | |

flush sliding doors

| | | | | | |
|----------------------|--|--|--|--|--|
| width 815 (32 1/8") | | | | | |
| width 979 (38 1/2") | | | | | |
| width 1307 (51 1/2") | | | | | |

DATASHEET

REGISTERED
DESIGN

IX.2018

NICHE door th 25 DESIGN VINCENT VAN DUYSSEN

Door with recessed handle.

All the hinged doors have cushion-closing hinges.

Hinges with 155° opening can be used on hinged doors.

Handles finishes

pewter colour
 bronze

Molteni & C

NICHE door
 matt lacquer colours
 glossy lacquer colours
 vertical grain wood

19 —

41

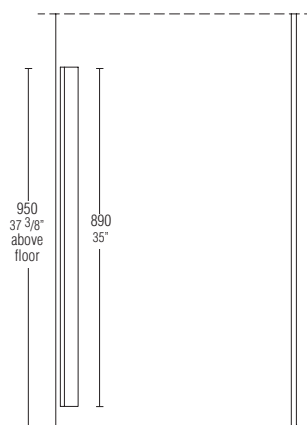

finishes

matt lacquer colours vertical grain wood glossy lacquer colours

hinged doors

| | matt lacquer colours | vertical grain wood | glossy lacquer colours |
|---------------------------|----------------------|---------------------|------------------------|
| width 487 (19 1/8") | | | |
| width 651 (25 5/8") | | | |
| width 815 (32 1/8") | | | |
| width 979 (38 1/2") | | | |
| width 1307 (51 1/2") | | | |
| door for terminal element | | | |

DATASHEET

REGISTERED
 DESIGN

IX.2018

GLASS door, th 35, 180° opening DESIGN VINCENT VAN DUYSSEN

Glass door with 180° opening made with a special soft close hinge inserted in the profile and completely hidden in the side (exclusively by Molteni).
A full height handle is designed in the profile.

Notes

GLASS doors are not available in H 2889.

In the pair of hinged doors, the handle is mounted on both doors in the pair.

The GLASS door can also be installed on the open corner module.

Molteni & C

GLASS door

20—
41

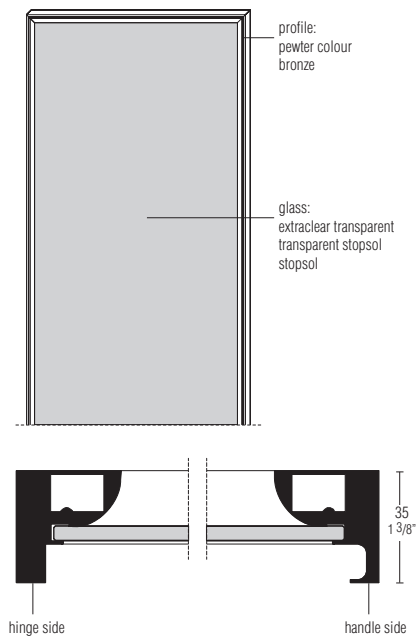

DATASHEET

REGISTERED
DESIGN

IX.2018

SWING door, th 35, 180° opening DESIGN VINCENT VAN DUYSSEN

Matt lacquered door with panel and perimeter profiles with a 180° opening made with a special soft close hinge inserted in the profile and completely hidden in the side (exclusively by Molteni).

Notes

SWING doors are not available in H 2889.

In the pair of hinged doors, the handle is mounted on both doors in the pair.

The SWING door can also be installed on the open corner module.

Molteni & C

SWING door

21—

41

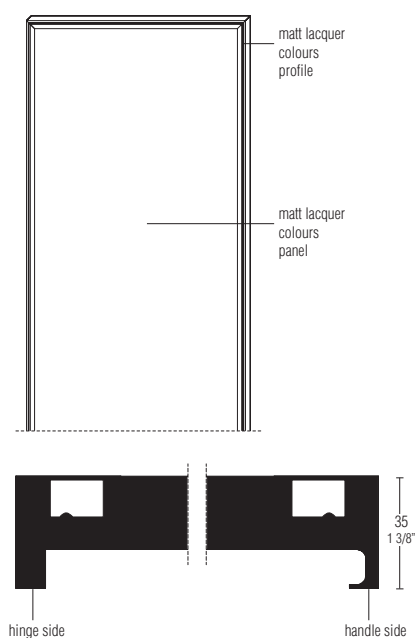

DATASHEET

REGISTERED
DESIGN

IX.2018

WINDOW door th 30 DESIGN VINCENT VAN DUYSSEN

Glass hinged door with pewter colour finished aluminium frame and lateral handle.

The doors are fitted with recessed hinges inserted in the base and top.

Notes

WINDOW doors are not available in H 2889.

In the pair of hinged doors, the handle is mounted on both doors in the pair.

Handle finishes

pewter colour

bronze

pewter colour covered in Eco Skin in the colours (with surcharge per handle)

bronze covered in Eco Skin in the colours (with surcharge per handle)

Molteni & C

WINDOW glass door

22—

41

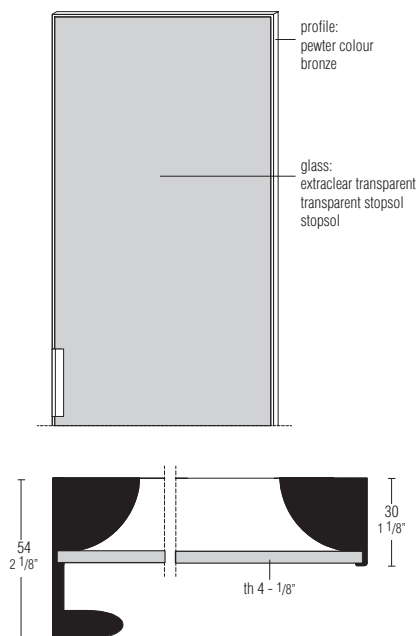

DATASHEET

REGISTERED
DESIGN

IX.2018

SKIN hinged door th 30 DESIGN VINCENT VAN DUYSSEN

Eco Skin covered hinged door with pewter colour and bronze finished aluminium frame and lateral handle.

The doors are fitted with recessed hinges inserted in the base and top.

The door is always divided into 3 equal parts.

Notes

SKIN doors are not available in H 2889.

In the pair of doors, the handle is mounted on both doors in the pair.

Handle finishes

pewter colour

bronze

pewter colour covered in Eco Skin in the colours (with surcharge per handle)

bronze covered in Eco Skin in the colours (with surcharge per handle)

Molteni & C

SKIN hinged door

23—
 41

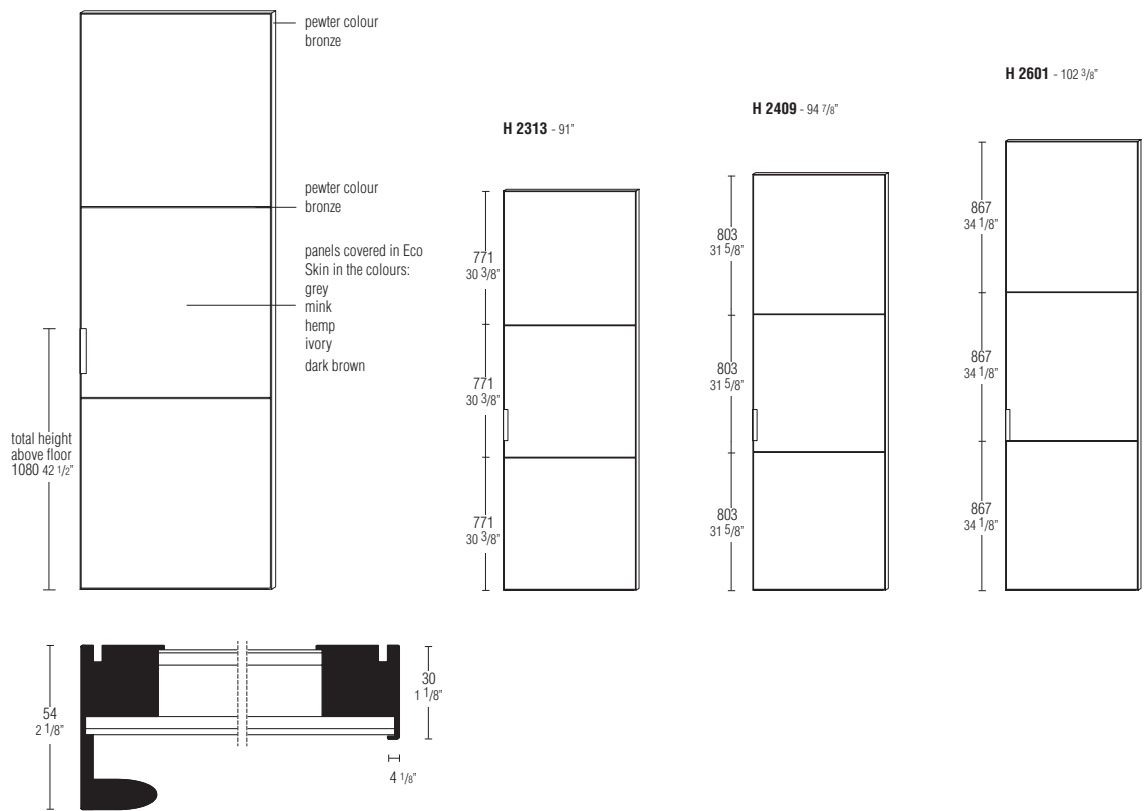

DATASHEET

REGISTERED
 DESIGN

IX.2018

SPECIAL ELEMENTS

Column with open compartment

- Can be inserted only in wardrobes without doors or with hinged doors.
- Central partitions and/or lateral pieces close the column and cannot be frame or glass.
- The open compartment is always in matt lacquered colours.
- Doors are always without handles because they protrude with respect to the structure.
- Drawers are fitted with the "E" handle of the START door.
- Front finish: melamine front, matt lacquered colours, glossy lacquered colours and wood.

* **The price does not include the central partitions or side panels, nor the internal shelves.**

Reductions

Reductions are allowed only in height, and costs of cutting the structure and doors are applied. Open compartment and lower part cannot be reduced.

Wire passage **EPA1** Ø 60 chrome on request on back.

Notes

The back of the open compartment cannot hold a mounted TV.

Molteni & C

24 —
 41

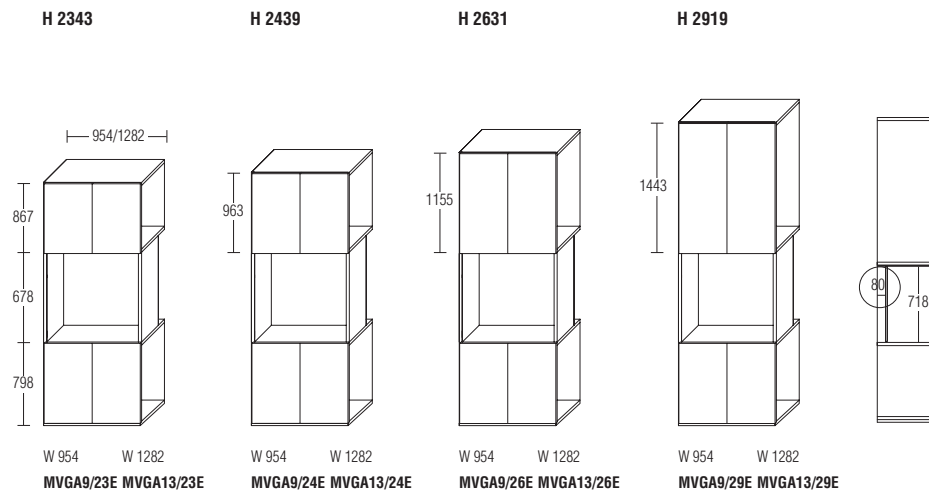
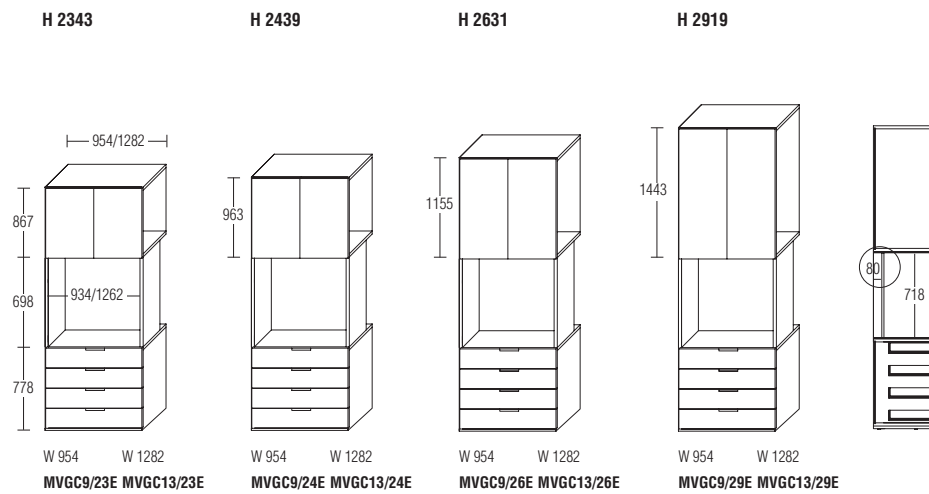

DATASHEET

REGISTERED
 DESIGN

IX.2018

SPECIAL ELEMENTS

Column with external drawers

- Can be inserted only in wardrobes with hinged doors.
- Central partitions and/or lateral pieces close the column and cannot be frame or glass.
- Pairs of doors always have only one handle mounted on the right door.
- Drawers are fitted with the "E" handle of the START door.
- Front finish: melamine front, matt lacquered colours, glossy lacquered colours and wood.

Reductions

Reductions are allowed only in height, and costs of cutting the structure and doors are applied.

* The price does not include the central partitions or side panels, nor the internal shelves.

Molteni&C

25—
 41

Doors with type "E" handle

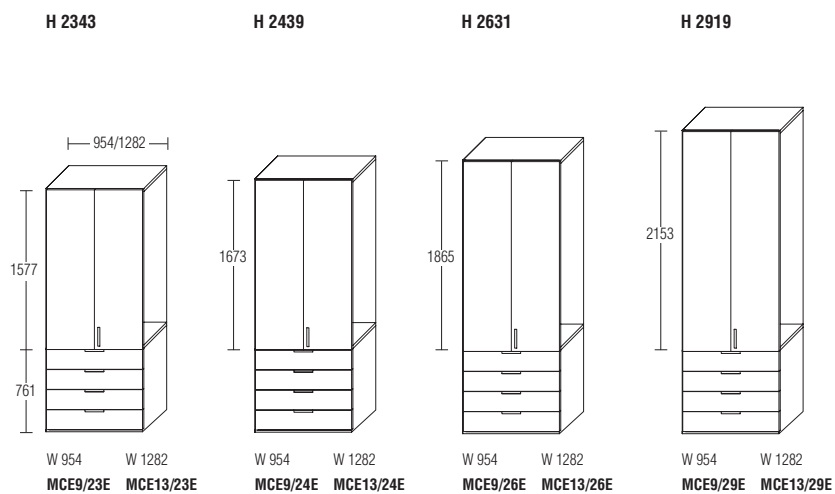

Doors with "A FILO" handle

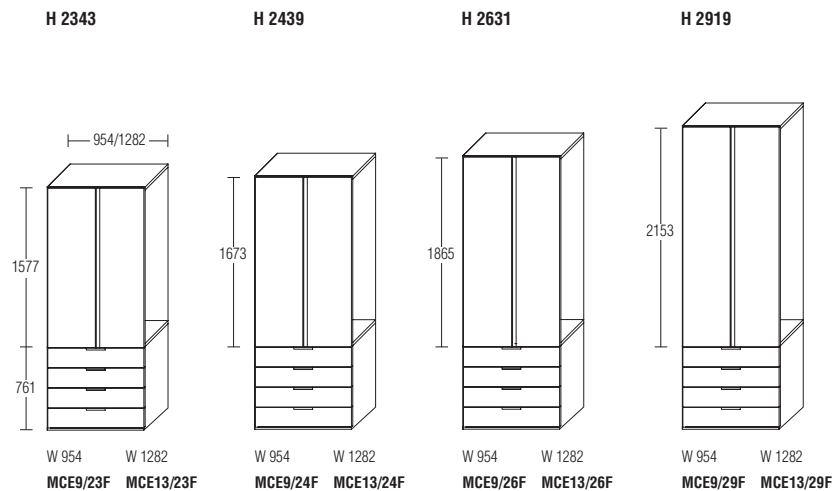

DATASHEET

REGISTERED
 DESIGN

IX.2018

FILLERS AND OPENING SIDE TRIMS

Horizontal filler

The filler is supplied in two parts, one part to be fixed to the ceiling to which the other will be hooked on (see diagram below).

The distance of the filler from the door is the client's decision.

In the cartapaglia finish, the grain direction is always vertical.

In the wood and graffiato finish, the grain direction is always horizontal.

Vertical filler

The vertical filler can be placed flush with the structure or the door.

This detail must be specified in the order to prepare the side panel (see example).

If this detail is not specified when placing the order, the filler will automatically be placed flush with the structure and the side panel will have the extension profile.

Opening fillers

Can be made with START and "A FILO" door. For handles, see surcharge.

Always have the 155° hinges.

Are the same height as the other doors in the composition.

Have a closing strip on their lower part.

In the wood finish, the grain direction is always vertical.

Horizontal filler side sections

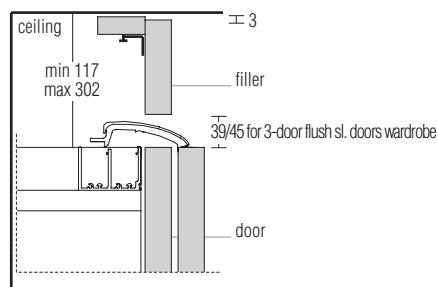
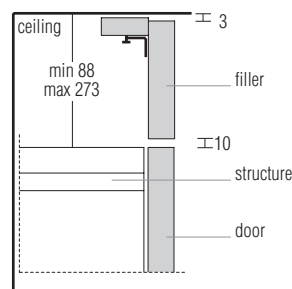

Vertical filler horizontal sections

Flush with structure

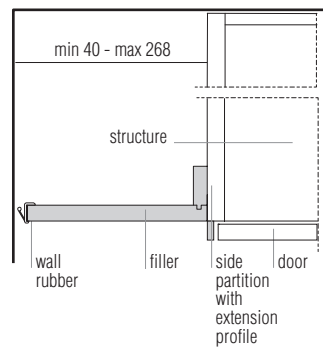

Flush with door

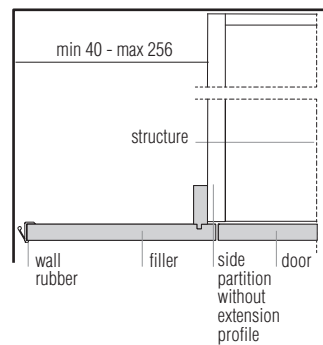

Set back

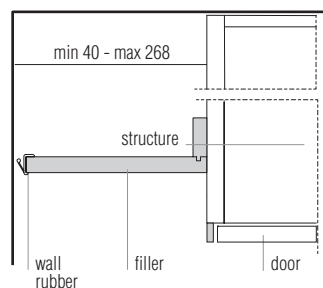

Opening filler horizontal sections

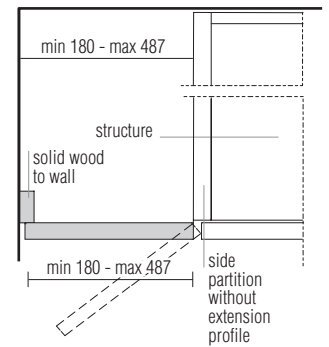

LIGHTING SYSTEM

Lighting bars with front LEDs

Internal compartments of Gliss Master wardrobes can be equipped with front LED lighting. The lighting bar can be applied to lids or to wooden, transparent glass and Eco Skin shelves. Using the electrified wire strip installed on the side (wood, frame or glass), the shelf can be moved. For each compartment length, we have made specific lighting bars with wiring compliant with European safety standards.

A wire strip is not needed if the compartment only has lighting on the top piece.

Lighting bars can be reduced with a surcharge for the shelf cutting.

Lighting shelves

It is possible to insert one or more lighting shelves in Gliss Master compartments. Using the electrified wire strip mounted on the side panel, the lighting shelf can be moved.

Lighting shelves can be connected to the wire strip on the left side panel or can be mounted without wire strip.

Notes

When placing the order, the customer must indicate how many shelves with lighting bars or lighting shelves are required. Lighting bars or lighting shelves can be placed in the same compartment. **For assembly: a lighting system on wardrobe with hinged doors requires a minimum extra height of 5 cm (2").**

Individual wire strip is always installed on the left side panel of the compartment, with the exception of corner units for walk-in wardrobes and of the compartment next to the corner unit.

When ordering, indicate compartments with wire strip.

Molteni & C

27—
41

| | | | | | | |
|---------------------------------------|-----------------|-----------------|------------------|------------------|-------------------|--------------------------------|
| lighting bars 3000 K | W 462 6 watt | W 626 8 watt | W 790 10 watt | W 954 12 watt | W 1282 16 watt | open corner element 20 watt |
|---------------------------------------|-----------------|-----------------|------------------|------------------|-------------------|--------------------------------|



| | | | | |
|---|------------------|------------------|------------------|-------------------|
| lighting shelves D 538 th 30 3000 K | W 626 12 watt | W 790 15 watt | W 954 18 watt | W 1282 30 watt |
|---|------------------|------------------|------------------|-------------------|



components per system
(see the diagram for component use and to calculate system cost)

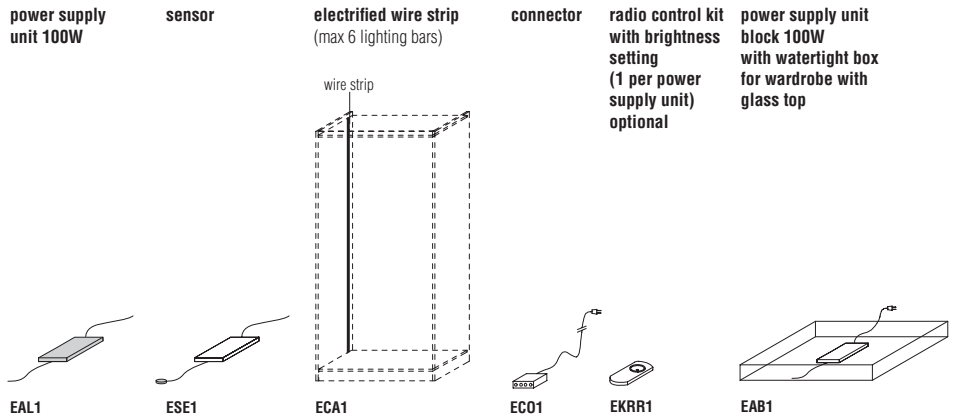

position of bar and wire strip on wooden partitions

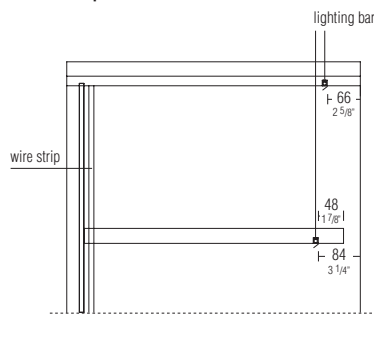

position of bar and wire strip on glass partitions

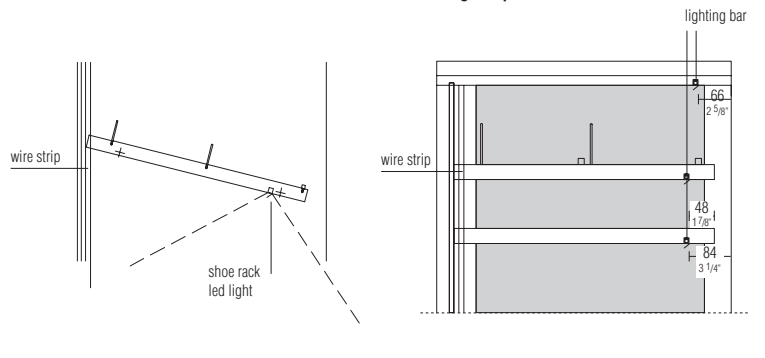

DATASHEET

REGISTERED
DESIGN

IX.2018

moltenigroup.com

Dimensions in millimeters and inches. The right to discontinue and make changes is reserved. This information is based on the latest product information available at the time of printing.

LIGHTING SYSTEM

System construction diagram

A composition (wardrobe) can be equipped with more than one system and more than one power supply unit. The system with sensor must be autonomous from the system with remote controlled electrical socket.

types of systems with sensors

system with sensor + wire strip suggested for wardrobes with doors

system with sensor (not for use with glass backs) suggested for wardrobes with doors and bars positioned only on the top piece

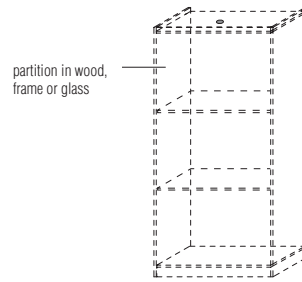
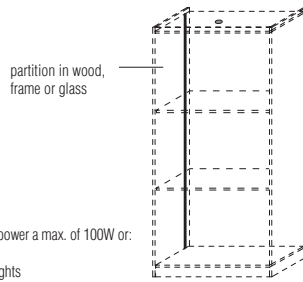

★ each power supply unit can power a max. of 100W or:
max 6 sensors
max 6 wire strip or 6 LED lights

| | | |
|---|---|---|
| sensor (1 per compartments) | ● | ● |
| power supply unit (per composition ★) | ● | ● |
| wire strips on lateral pieces (per compartment) | ● | |
| connector (for compositions of 4 power supply units max.) | ● | ● |

types of systems with remote control electrical socket or radio remote control

one radio remote control unit can control systems with 2 power supply units max. Otherwise, more radio remote control units must be used.

system with wire strip for remote control electrical socket suggested for wardrobes without doors (walk-in wardrobes) and glass doors

system with remote control electrical socket (not for use with glass backs) suggested for wardrobes without doors (walk-in wardrobes) and glass doors

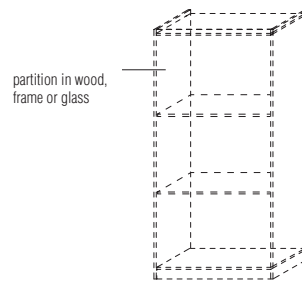
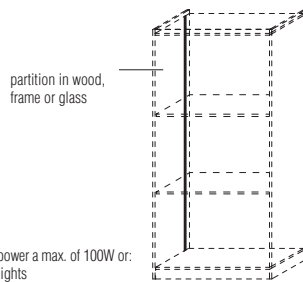

★ each power supply unit can power a max. of 100W or:
max 6 wire strips or 6 LED lights

| | | |
|---|--------------|--------------|
| power supply unit (per composition ★) | ● | ● |
| wire strips on lateral pieces (per compartment) | ● | |
| connector (for compositions of 4 power supply units max.) | ● | ● |
| radio remote control (optional) | ● (optional) | ● (optional) |

DALI kit (for DOMOTICA)

n. 1 for each power supply unit
cannot be used with
radio remote control

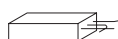

EKDA1

INTERNAL ACCESSORIES

Aircub is an air purifier and aroma diffuser that eliminates up to 95% of the harmful agents inside wardrobes through a process of ionisation and ozonation. Aircub can be managed easily from your smartphone with a dedicated app. Aircub can be installed on the back panel of each compartment. Just plug it into the electrical socket and turn it on. Every Aircub has a single plug. Up to 3 Aircubs per wardrobe can be installed using the specific multi-socket connector.

Aircub - air purifier
W 270 D 28 H 120
W 10 5/8" D 1 1/8" H 4 3/4"
(cable length L3m)

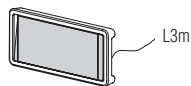

EAC1

product advantages

- improves air quality
- reduces bacteria that cause foul odours
- prevents mould and miles from forming
- dispenses fragrance
- does not have filters that require maintenance or changes
- includes n.1 fragrance pod

multi-socket connector
cable length 3m
W 250 D 60 H 40
W 9 7/8" D 2 3/8" H 1 5/8"

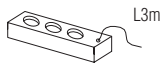

EAC2

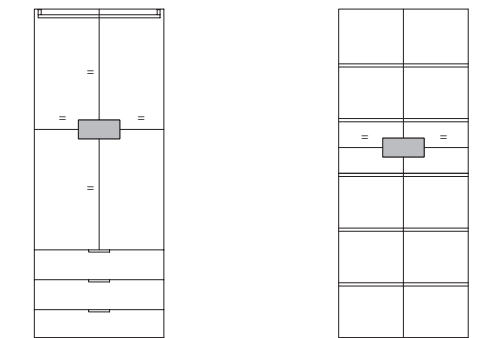

**For correct function it is advisable
to position the Aircub at the centre
of the compartment**

DATASHEET

REGISTERED
DESIGN

IX.2018

INTERNAL FITTINGS

Internal fittings
with wooden sides

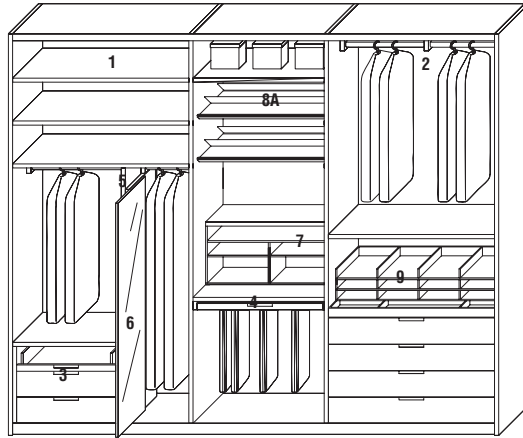

Internal fittings
with frame or glass sides

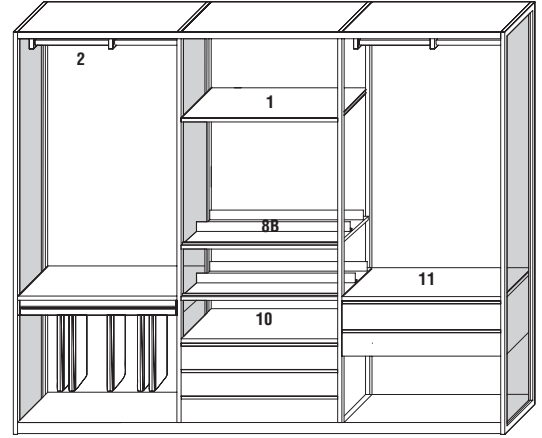

- 1** Shelf th 30 mm (wood, glass, Eco Skin)
- 2** Clothes rail
- 3** Modular drawer unit only for wooden sides
- 4** Trousler holder
- 5** Central divider piece th mm 30 only for compart. with wooden sides
- 6** Swivel pull-out mirror only for compart. with wooden sides
- 7** Shirt and sweater holder grid only for wood sides
- 8A** Inclined shoe rack shelf only for wooden sides
- 8B** Horizontal shoe rack shelf only for frame or glass sides
- 9** Pull-out shirt holder only for wooden sides
- 10** Floor standing drawer unit only for compart. with frame or glass sides
- 11** Suspended drawer unit only for compart. with frame or glass sides

Section of internal fittings

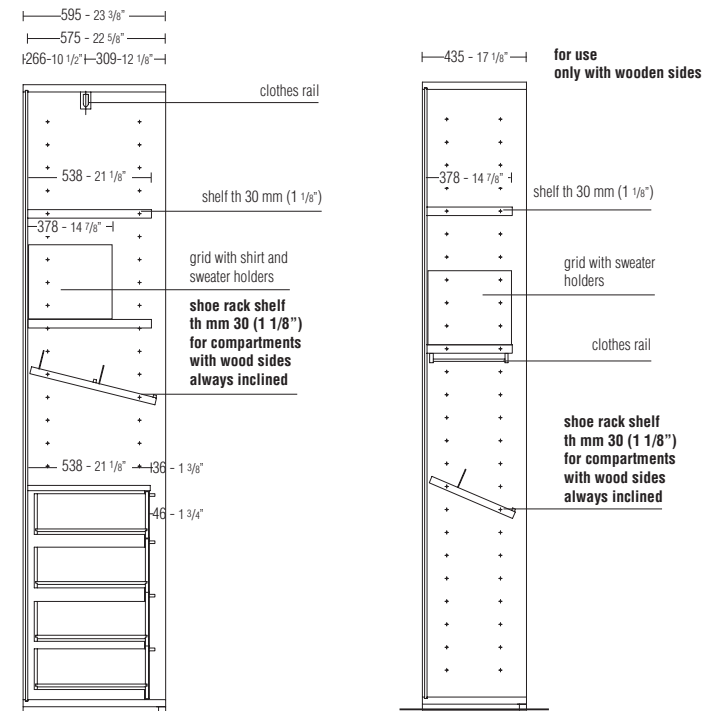

Molteni & C

30—
41

DATASHEET

REGISTERED
DESIGN

IX.2018

INTERNAL FITTINGS - SHELVES, SHOE RACK SHELVES

Molteni & C

31—
41

wood shelves - top shelves (only D 538)

D 538 th 30
D 378 th 30



| | | | | | |
|-------------|-------------|-------------|-------------|-------------|--------------|
| W 298 | W 462 | W 626 | W 790 | W 954 | W 1282 |
| RI/3 | RI/4 | RI/6 | RI/8 | RI/9 | RI/13 |

shelf for open corner element th 30

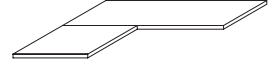

| | |
|---------------|---------------|
| 1081x1081 | 1262x1262 |
| RIA/11 | RIA/13 |

glass shelves can be fitted with front LED light bars and comply with the wiring standards

transparent glass shelves

D 538 th 30
D 378 th 30



| | | | | |
|-------------|-------------|-------------|-------------|--------------|
| W 462 | W 626 | W 790 | W 954 | W 1282 |
| RV/4 | RV/6 | RV/8 | RV/9 | RV/13 |

not for use in compartments adjacent to the corner element in wardrobes with doors

Eco Skin shelves can be fitted with front LED light bars and comply with the wiring standards

Eco Skin shelves - shelves with Eco Skin cover (only D 538)

D 538 th 30
D 378 th 30

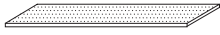

| | | | | | |
|-------------|-------------|-------------|-------------|-------------|--------------|
| W 298 | W 462 | W 626 | W 790 | W 954 | W 1282 |
| RE/3 | RE/4 | RE/6 | RE/8 | RE/9 | RE/13 |

Eco Skin shelf for open corner element th 30

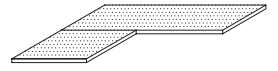

| | |
|---------------|---------------|
| 1081x1081 | 1262x1262 |
| REA/11 | REA/13 |

When ordering, specify the finish Eco Skin and profile

Shoe rack shelves

Shoe rack shelves can be used with wood sides and with frame or glass sides. When inserted between wood sides, this part will always be inclined (example 1). When there are frame or glass sides, this part will always be horizontal (example 2).

Notes

To hook to the frame or glass sides, add the price of the relative metal profiles.

example 1

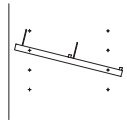

shoe rack shelves

D 538 th 30

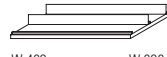

| | | | | |
|--------------|--------------|--------------|--------------|---------------|
| W 462 | W 626 | W 790 | W 954 | W 1282 |
| RSP/4 | RSP/6 | RSP/8 | RSP/9 | RSP/13 |

example 2

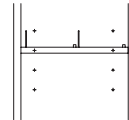

example 1

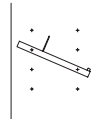

shoe rack shelves

D 368 th 30



| | | | | |
|--------------|--------------|--------------|--------------|---------------|
| W 462 | W 626 | W 790 | W 954 | W 1282 |
| RQP/4 | RQP/6 | RQP/8 | RQP/9 | RQP/13 |

metal profile for attaching shelves to frame side



PST

metal profile for attaching shelves to glass side



PSV

metal profile for attaching shelves with LEDs to frame side (always on the left, except in corner shelves)



PSE

DATASHEET

REGISTERED
DESIGN

IX.2018

moltenigroup.com

Dimensions in millimeters and inches. The right to discontinue and make changes is reserved. This information is based on the latest product information available at the time of printing.

**INTERNAL FITTINGS - CLOTHES RAILS, HANGER RAILS, PULL-DOWN HANGERS,
 CENTRAL DIVIDER PIECES**

Molteni & C

32—
 41

clothes rails



W 298 W 462
PO/3 PO/4

W 626 W 790
PO/6 PO/8

W 954 W 1282
PO/9 PO/13

**clothes rail for
 corner compartment
 with doors**



POA/6

**clothes rail
 for D 435**

to mount on wood shelves or
 top only with hinged doors

nr. 1 piece on compartment W 626/790
 nr. 2 pieces on compartment W 954/1282

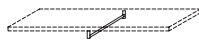

PO0/4

**clothes rails
 for open corner
 compartment**

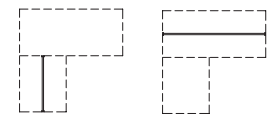

W 723
POA/7

W 1262
POA/13

pull-out coat hanger rail

for melamine shelf (without profile) th 30



OP7

**hanger
 W 450**

beech stained grey
 (package of 10 pieces)



OP10

**hanger with clips
 W 450**

beech stained grey
 (package of 3 pieces)



OP11

Maximum
 load-bearing capacity
 10 kg

pull-down hanger

H mm 1040
 for compart. W 626

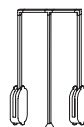

SER/6

for compart. W 790

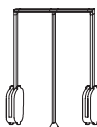

SER/8

for compart. W 954

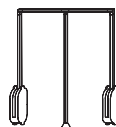

SER/9

for compart. W 1282

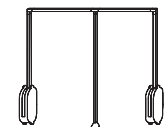

SER/13

When ordering, specify
 the finish of the front profile:
 pewter colour or bronze

**floor standing
 central divider pieces**

D 538 th 30



SDT/04

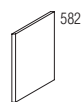

SDT/05

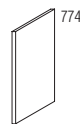

SDT/07

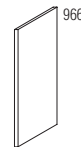

SDT/09

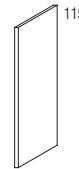

SDT/11

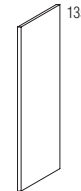

SDT/13

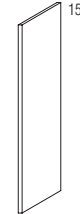

SDT/15



SDT/17

DATASHEET

REGISTERED
 DESIGN

IX.2018

GLASS LID FOR CHEST OF DRAWERS

To be used only in compartments with wooden sides

Modular chests of drawers can be made with a transparent glass lid in the module widths 790/954/1282.

It is mandatory that the first drawer be H 190 in wood (special measure).

The top can be fitted with a LED lighting bar, but it cannot be connected to the cable holder.

The connection to the power cord has to pass behind the back panel.

Eco Skin bottoms in grey can be inserted.

Molteni & C



W 790
CSV/08

W 954
CSV/09

W 1282
CSV/13

33—

41

Example of use

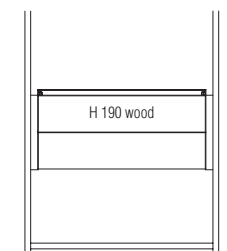

DATASHEET

REGISTERED
DESIGN

IX.2018

INTERNAL FITTINGS - MOVABLE TRAYS SET

Only for use in compartments with wooden sides

These units can be positioned on the floor-standing drawer units or suspended over a drawer H 190 of the same dimensions as the unit (see ex. 1).
 The price of the blocks does not include the shelf covering the drawer unit.

Finishes

The trays are always made in melamine in the finish of the structure with bottom in grey Eco Skin.
 The trinket tray is always dolomite lacquered.

example 1

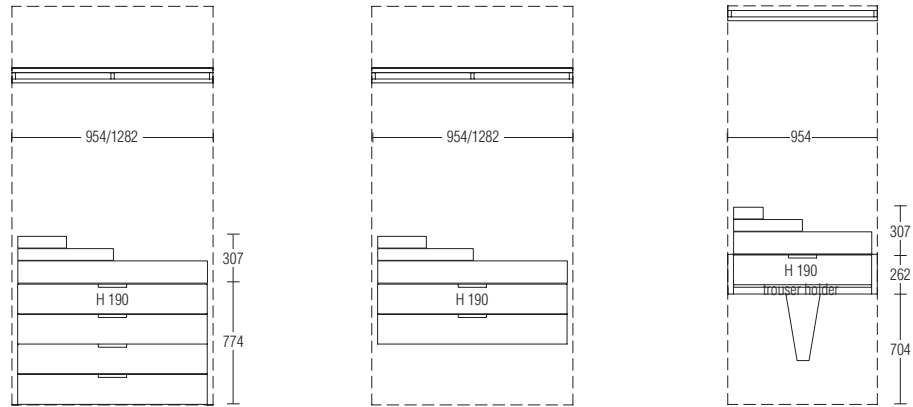

Molteni & C

34 —
 41

The price of the blocks does not include the shelf covering the drawer unit

for compartment
 W 954

for compartment
 W 1282

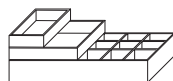

BVS9/03/1

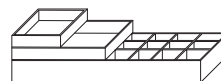

BVS13/03/1

DATASHEET

REGISTERED
 DESIGN

IX.2018

INTERNAL FITTINGS - PULL-OUT SHIRT HOLDER - GRID WITH SHIRT AND SWEATER HOLDERS

Pull-out shirt holder only for use in compartments with wooden sides

These units can be positioned on the floor-standing drawer units or suspended over a drawer H 190 of the same dimensions as the shirt unit (see ex. 1).

Finishes

The tray set on top of the shelf is always finished in melamine in the same finish as the structure with Eco Skin bottom grey finish.
The shirt holder grid is always dolomite lacquered.

example

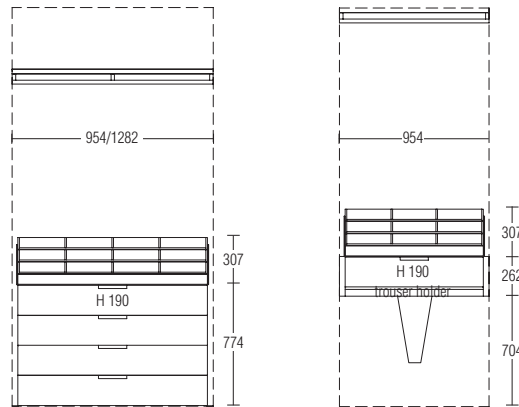

When ordering, specify the finishes of the trays set on shelves and the shirt holder grid

for compartment
W 954
including resting shelf

for compartment
W 1282
including resting shelf

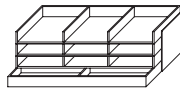

BPC9/03/1

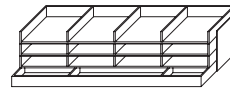

BPC13/03/1

Grid with shirt and sweater holders

These elements are fixed and to be used set on shelves or on drawer units.
Only in compartments with wood sides.

Grid with shirt and sweater holders

W 626 D 378 H 480

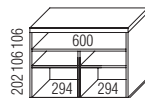

BGR6/05/1

W 790 D 378 H 480



BGR8/05/1

W 954 D 378 H 480

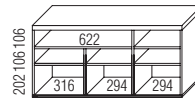

BGR9/05/1

W 1282 D 378 H 480

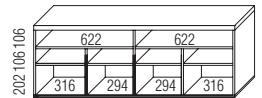

BGR13/05/1

Examples of use

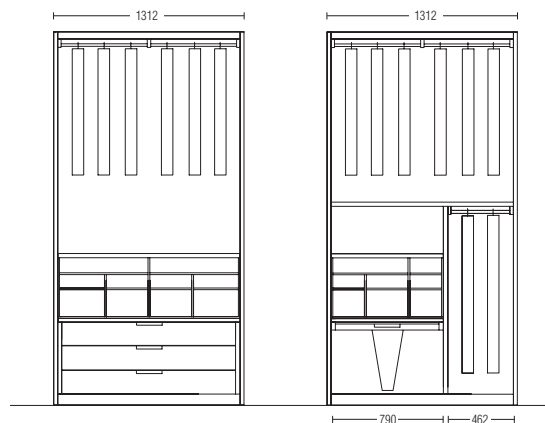

Molteni & C

35—
41

DATASHEET

REGISTERED
DESIGN

IX.2018

moltenigroup.com

Dimensions in millimeters and inches. The right to discontinue and make changes is reserved. This information is based on the latest product information available at the time of printing.

INTERNAL FITTINGS - MIRRORS

Procedure for using the swivel pull-out mirror

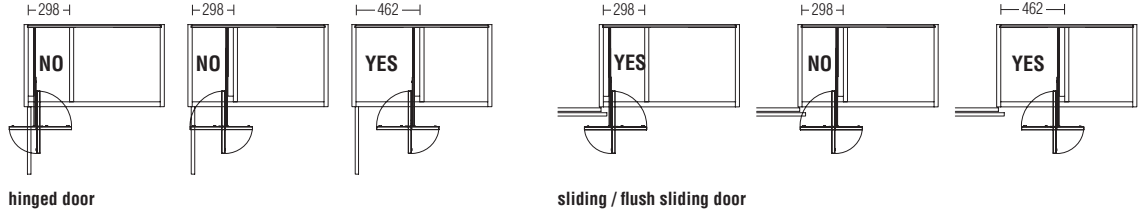

Molteni & C

36—
 41

mirror
 applied to inside of
 hinged door
 W 315 H 1600 th 4

swivel pull-out mirror
 to be applied onto the side,
 partition or central divider pieces
 D 555 H 1443 th 90



SPECH

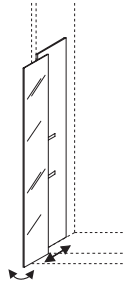

SPECS/17

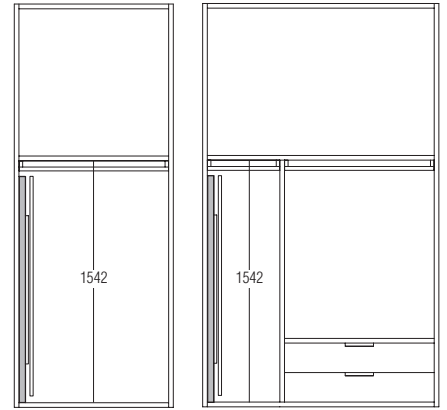
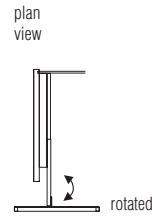

DATASHEET

REGISTERED
 DESIGN

IX.2018

INTERNAL FITTINGS - MODULAR DRAWERS AND TRAYS

Notes

The parts of this internal fittings are produced with width and height dimensions corresponding to the modular compartments. This makes it possible to organise the internal spaces in a number of ways. To correctly and quickly determine the internal fittings, some of the possible compositions are in the following pages.

The pairs of side panels suspended or resting on the floor are essential for inserting all the elements.

Compositions must be completed with a top shelf.

When ordering, specify the handle finish as pewter colour or bronze.

No reductions of any kind can be made on drawers, trays and pairs of side panels.

Warnings on using compartments adjacent to the corner element

It is impossible to use trouser or trinket trays (used individually).

Wooden drawer finishes

melamine front in structure finish

fine grain finish front with pewter colour or bronze profile

drawer inside in grey saffiano melamine

Glass drawer finishes

transparent glass front with pewter colour or bronze frame

inside in grey saffiano melamine

Open drawer finishes

melamine front in structure finish

inside in grey saffiano melamine

Molteni & C

Items available

37—

41

Wooden drawers (melamine or fine grain)

STANDARD handle (pewter colour, bronze or Eco Skin finish)

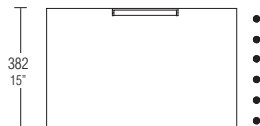
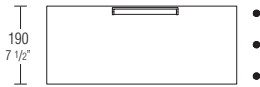

416 - 580 - 716 - 880 - 1208
16 3/8 - 22 7/8 - 28 1/4 - 34 5/8 - 47 1/2

HOLD handle (pewter colour or bronze finish)



416 - 580 - 716 - 880 - 1208
16 3/8 - 22 7/8 - 28 1/4 - 34 5/8 - 47 1/2

Glass drawers



416 - 580 - 716 - 880 - 1208
16 3/8 - 22 7/8 - 28 1/4 - 34 5/8 - 47 1/2



416 - 580 - 716 - 880 - 1208
16 3/8 - 22 7/8 - 28 1/4 - 34 5/8 - 47 1/2

Open drawers

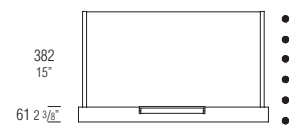
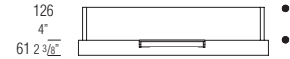

416 - 580 - 716 - 880 - 1208
16 3/8 - 22 7/8 - 28 1/4 - 34 5/8 - 47 1/2

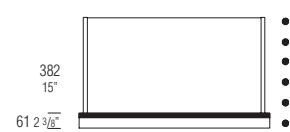

416 - 580 - 716 - 880 - 1208
16 3/8 - 22 7/8 - 28 1/4 - 34 5/8 - 47 1/2

DATASHEET

REGISTERED
DESIGN

IX.2018

INTERNAL FITTINGS - MODULAR DRAWERS AND TRAYS

Trouser holder finishes

melamine front in the same finish as the structure or fine grain with pewter colour or bronze profile
 inner frame in grey saffiano melamine with trouser holder in grey saffiano embossed

Trinket tray finishes

melamine front in the same finish as the structure or fine grain with pewter colour or bronze profile
 inner frame, bottom and grid in grey saffiano melamine

Pull-out trays finishes

melamine front in structure finish
 with shelf and back in grey saffiano melamine

STANDARD handle (pewter colour, bronze or Eco Skin finish)

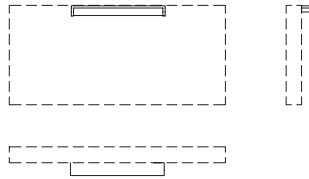

HOLD handle (pewter colour or bronze finish)



Notes

Prices of drawers, trays and pull-out trays include the cost of the pewter colour or bronze finish STANDARD handle. For the STANDARD handle covered in Eco Skin, add a supplementary charge for each.

Molteni & C

38—
 41

Trouser holder

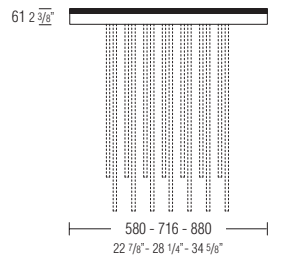
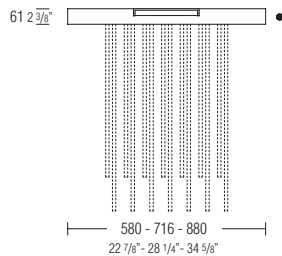

N.B.: usable only with suspended side panels as the bottom piece

Trinket trays (tie and belt) with internal grid

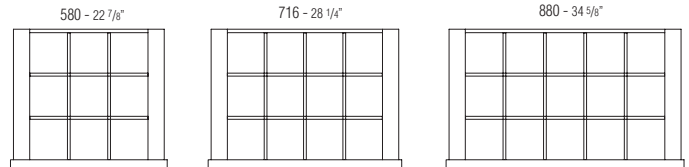
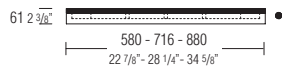
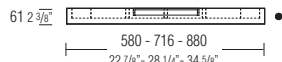

internal tray dividers

Pull-out trays

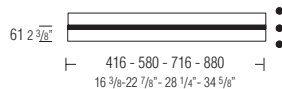
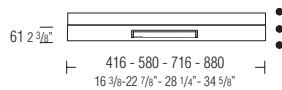

DATASHEET

REGISTERED
 DESIGN

IX.2018

moltenigroup.com

Dimensions in millimeters and inches. The right to discontinue and make changes is reserved. This information is based on the latest product information available at the time of printing.

INTERNAL FITTINGS - ACCESSORIES FOR DRAWERS

Leather trays
Handmade leather trays with Alcantara bottom.
The version for men is brown (cat. P col. D533),
The version for women is powder pink (cat. P col. D524).

Eco Skin bottoms
Made with grey coloured Eco Skin.

Molteni & C

39 —
41

**leather trays
men's drawers**
W 206 D 430 H 58 (A)
W 206 D 215 H 58 (B)

**watch holder
(A)**

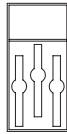

CEV/MA1

**watch/
bracelet holder
(A)**

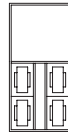

CEV/MA2

**jewellery holder
with movable dividers
(B)**



CEV/MB1

**complete men's
drawer offer**

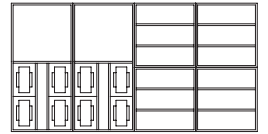

CVM1

**leather trays
women's drawers**
W 206 D 430 H 58 (A)
W 206 D 215 H 58 (B)

**watch holder
(A)**

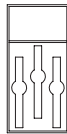

CEV/WA1

**watch/
bracelet holder
(A)**

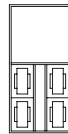

CEV/WA2

**jewellery holder
with movable dividers
(B)**



CEV/WB1

**ring holder
(B)**



CEV/WB2

**earring holder
(B)**



CEV/WB3

**complete women's
drawer offer**



CVW1

**Modularity drawings
for inserting trays into
drawers**

drawer W 416

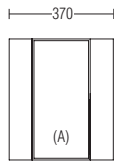

1 tray (A)
or 2 trays (B)

drawer W 580

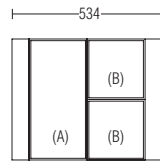

2 trays (A)
or 4 trays (B)

drawer W 716

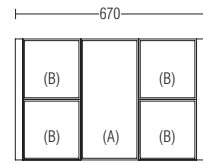

3 trays (A)
or 6 trays (B)

drawer W 880

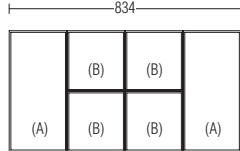

4 trays (A)
or 8 trays (B)

drawer W 1208

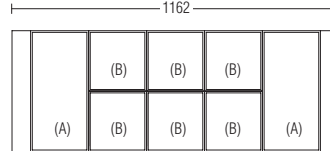

5 trays (A)
or 10 trays (B)

**Eco Skin bottoms
for drawers**

D 432/473 special for 1st drawer with glass lid



W 366
CEQ/F4

W 530
CEQ/F6

W 666
CEQ/F8

W 830
CEQ/F9

W 1158
CEQ/F13

DATASHEET

REGISTERED
DESIGN

IX.2018

ISLAND DRAWER UNIT - DRAWER UNIT

Island drawer unit

Made completely in larix dark or silver cembran melamine and available in two versions: with or without trinket trays in dolomite lacquer. Shelves in Eco Skin are available in colours in the catalogue. Standard handles are mounted, in pewter colour or bronze finish. It is possible to make STANDARD handles covered in Eco Skin with a supplemental charge for each.

version with trinket trays

- Side A has 6 drawers H 190 and 2 extractable trinket tray blocks.
- Side B has 4 drawers H 190 and and lower open compartments.

version without trinket trays

- Side A has 6 drawers H 190 and upper open compartment.
- Side B has 4 drawers H 190 and and lower open compartments.

Dimensions of the island cannot be reduced, and the composition cannot be modified.

It is possible to substitute the melamine drawers with glass drawers by adding the difference in price from **CLN8/19** and **CVN8/19**.

It is possible to substitute the melamine drawers with drawers with fine grain fronts by adding the difference in price of the finishes of the code **CLN8/19**.

Molteni & C

40 —
 41

island drawer unit with trinket trays

W 1518 D 1022 H 897
 W 59 3/4" D 40 1/4" H 35 3/8"

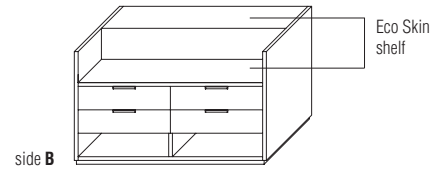
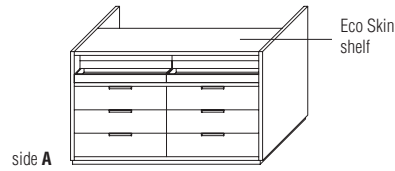

larix dark/silver cembran:
 STANDARD handle
 HOLD handle

ISC15/09/1

island drawer unit without trinket trays

W 1518 D 1022 H 897
 W 59 3/4" D 40 1/4" H 35 3/8"

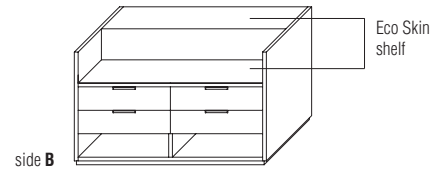
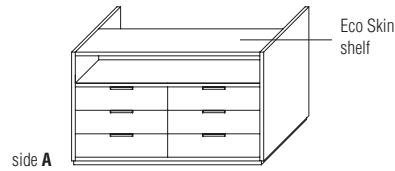

larix dark/silver cembran:
 STANDARD handle
 HOLD handle

ISC15/09/2

Drawer unit

Made in larix dark, silver cembran or matt lacquer in Molteni range colours. Standard handles are mounted, in pewter colour finish. It is possible to make STANDARD handles covered in Eco Skin with a supplemental charge for each.

drawer unit

W 1292 D 527 H 897
 W 50 7/8" D 20 3/4" H 35 3/8"

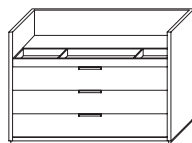

STANDARD handle HOLD handle
ISC13/09/1

DATASHEET

REGISTERED
 DESIGN

IX.2018

ISLAND WITH TRANSPARENT GLASS DOORS

Island that can be created with structure in transparent glass and horizontal parts in wood. Shelves are in wood except for those indicated (*) which are always in glass.

The island cannot be reduced or modified with respect to the versions in the price list.

Structure finish
 pewter colour
 bronze

Base unit / top / shelf finishes
 eucalyptus
 graphite oak

H 880 - 34 5/8"
 with top
D 1000 - 39 3/8"

W 1673 - 65 7/8"

W 2001 - 78 3/4"

Molteni & C

41 —
 41

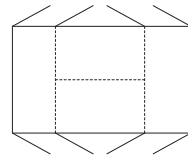
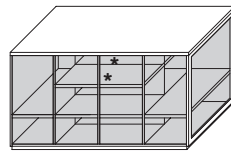

ISV16/08

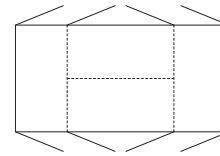
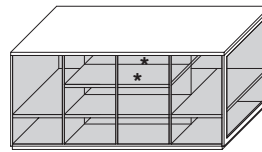

ISV20/08

without LEDs
 with LEDs

The island is available with or without LED lighting applied on all shelves and tops as shown. The system includes the cable holders and power supply units that enable it to work with a remote control.

front

back

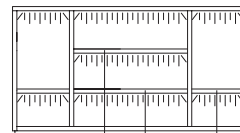
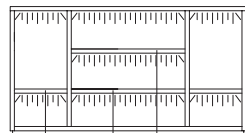

*
 glass
 shelves
 wood
 shelves

DATASHEET

REGISTERED
 DESIGN

IX.2018

Molteni & C

FINISHES MOLTENI&C RANGE

IX.2018

| | MATT LACQUER | GLOSSY LACQUER | COLOURED GLASS | ETCHED COLOURED GLASS | CARTAPAGLIA LACQUERED <i>only Gliss Master</i> | STOPSOL GLASS TRANSPARENT STOPSOL GLASS |
|-----------------|--------------|-------------------|----------------|-----------------------|---|--|
| CHALK WHITE | • | • | • | • | • | |
| PEARL | • | • | • | • | • | |
| SILICA | • | • | • | • | • | |
| SAND | • | • | • | • | • | |
| DOVE GREY | • | • | • | • | • | |
| PLATINUM | • | • | • | • | • | |
| DUNE | • | • | • | • | • | |
| CLAY | • | • | • | • | • | |
| DOLOMITE GREY | • | • | • | • | • | |
| COPPER | • | • | • | • | • | |
| RUST | • | • | • | • | • | |
| RUBY | • | • | • | • | • | |
| CARAMEL | • | • | • | • | • | |
| MOKA | • | • | • | • | • | |
| MUSTARD | • | • | • | • | • | |
| LIGHT BLUE GREY | • | • | • | • | • | |
| PEWTER COLOUR | • | • | • | • | • | |
| ANTHRACITE | • | • | • | • | • | |
| BLACK | • | • | • | • | • | |
| STOPSOL | | | | | | • |
| LESSLESS RED | • | | | | | |
| | | only matt lacquer | | | | |

Molteni & C

FINISHES MOLTENI&C RANGE

IX.2018

WOODS

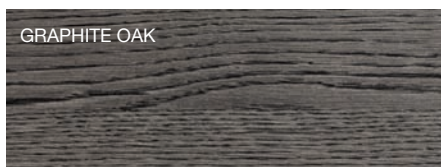
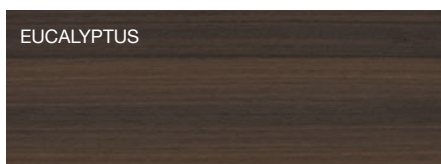

MARBLES

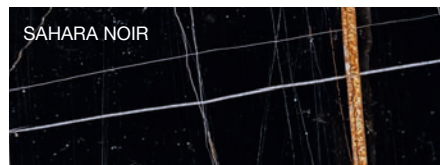
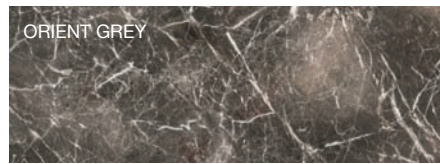
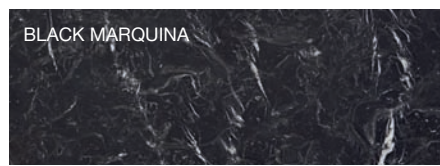
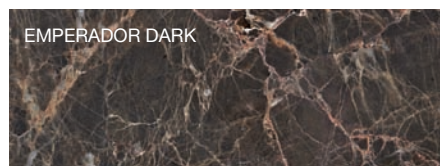
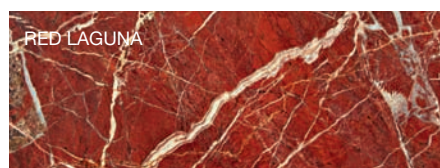
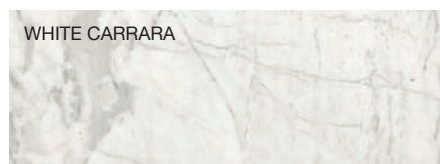

METAL PARTS

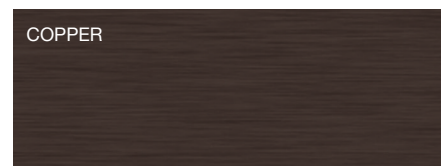
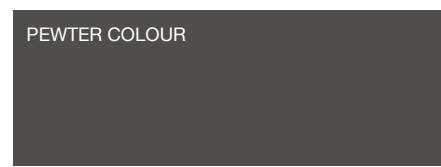
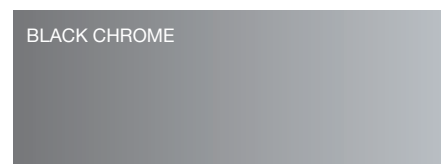

The finishes shown are indicative and refer to the entire production range. We recommend that you consult the "Colour Range" samples which shown the complete range of finishes, including those not shown here. Molteni&C reserves the right to modify the range without warning.

Molteni & C

FINISHES MOLTENI&C RANGE

IX.2018

MELAMINE FRONT
GLISS MASTER

CARTAPAGLIA WHITE



CARTAPAGLIA ANTHRACITE

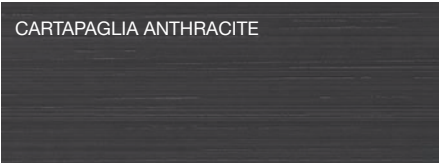

CARTAPAGLIA SILICA



GRAFFIATO SILICA



GRAFFIATO BRONZE



SILK DOVE GREY



SILK SILICA



SILK CHALK WHITE



MELAMINE STRUCTURE
GLISS MASTER

WHITE SHANTUNG

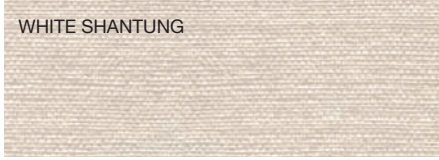

GREY SHANTUNG



MELAMINE STRUCTURE
GLISS MASTER, MASTER DRESSING,
GLISS WALK-IN

SILVER CEMBRAN

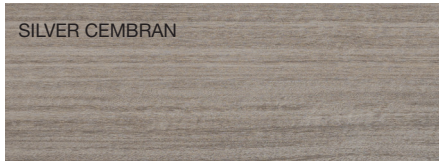

LARIX DARK

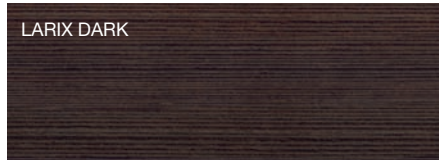

MELAMINE STRUCTURE
GLISS MASTER, MASTER DRESSING

WHITE



ECO SKIN

IVORY



HEMP



MINK



DARK BROWN



GREY



FINE GRAIN

FINE GRAIN

